



**INTRUSAFE**

An Innovia Medical Brand

**Product Catalog**

*YOUR TRUSTED PARTNER FOR  
SUPERIOR INSTRUMENT PROTECTION*

INTRUSAFE STERILIZATION TRAY ADVANTAGE	
360° OF PROTECTION	2
INDUSTRY DISADVANTAGES	4
FEATURES + BENEFITS	6
ORDER PROCESS: THE INSTRUSAFE WAY	8
STERILIZATION BARRIERS + FOOT OPTIONS	10
TRAYS BY PROCEDURE	
<span style="color: #C00000;">■</span> ARTHROSCOPY	12
<span style="color: #FFA500;">■</span> BARIATRIC	14
<span style="color: #008080;">■</span> CARDIOVASCULAR	16
<span style="color: #000080;">■</span> DENTAL	19
<span style="color: #FF0066;">■</span> ENT	21
<span style="color: #8B0000;">■</span> GENERAL	34
<span style="color: #008000;">■</span> GYNECOLOGY	38
<span style="color: #6A5ACD;">■</span> NEUROLOGY/SPINE	40
<span style="color: #00CED1;">■</span> OPHTHALMOLOGY	46
<span style="color: #DC143C;">■</span> ORTHOPEDIC	50
<span style="color: #8B0000;">■</span> PLASTICS	52
<span style="color: #DDA0DD;">■</span> RETRACTORS	54
<span style="color: #FFD700;">■</span> SCOPES	58
ROBOTIC TRAYS	
<span style="color: #000080;">■</span> DA VINCI®	68
<span style="color: #000080;">■</span> HUGO™ RAS	78

TRAY ACCESSORIES	
SILICONE SMALL PARTS BOXES	80
PLAQUE OPTIONS	81
FINGER MATS	82
GUARDIAN™ TRAY	82
INSTRU-ZYME®	83
ROUNDERS® POINT GUARDS®	83

TRANSPORT CONTAINERS	
XL TRANSPORT CONTAINERS	84
HEAVY DUTY TRANSPORT CONTAINERS	86
TRANSPORT CONTAINERS	87

INTRUSAFE RIGID CONTAINER ADVANTAGE	
FEATURES + BENEFITS	88

RIGID CONTAINERS	
<span style="color: #008080;">■</span> HALF SIZE CONTAINERS	90
<span style="color: #C00000;">■</span> THREE QUARTER SIZE CONTAINERS	92
<span style="color: #FFA500;">■</span> FULL SIZE CONTAINERS	94
<span style="color: #483D8B;">■</span> XL SIZE CONTAINERS	96

RIGID CONTAINER ACCESSORIES	
LOCKS, FILTERS + DATA CARDS	98
PLAQUE OPTIONS	99

RIGID CONTAINER RESOURCES	
METRIC MEASUREMENT TABLE	100
TRAY CROSS REFERENCE	101
WISH-LIST	102



**SUBMIT PURCHASE ORDERS TO:**

**US + INTERNATIONAL ORDERS**  
**Summit Medical LLC**  
 815 Vikings Parkway, Ste 100  
 St. Paul, MN 55121 USA  
 1-888-229-2875 | +1 (651) 789-3939  
 www.instrusafe.com

**UK ORDERS**  
**DTR Medical Ltd**  
 17 Clarion Court, Clarion Court Enterprise Park  
 Swansea SA6 8RF UK  
 +44 (0) 1792 797910  
 www.dtrmedical.com

# The InstruSafe® Advantage

## 360° of Protection

The use of complex and delicate instrument sets is a new reality in which sterile processing and the operating room live. Intricacy of surgical instrumentation continues to increase, and so does the cleaning and sterilization process. Now, healthcare facilities face the challenge of reprocessing instruments safely and efficiently while also meeting the demand for fast turnaround. Keeping these sets organized and protected upon arrival in the operating room creates a challenge for all involved. Relieve yourself of these daily obstacles with InstruSafe Trays—an everyday solution for the intricacies of your instrument sets.

We have spent over 30 years understanding the use cycle and improving outcomes. With these goals in mind, we have created a product that eliminates common frustrations associated with instrument sets. The products in this catalog are a compilation of our hard work. As you journey through the pages, let us help you solve your everyday instrument problems.

Our most recent validations and product advancements are a testament of our dedication to our customers' satisfaction. We wouldn't have continuing success without the healthcare community we serve. Focus, determination and your support will continue our impact on patient care for decades to come.



*Designed to organize and protect from the operating room to decontamination, our solutions benefit everyone who handles our products.*

InstruSafe Sterilization Trays have undergone rigorous testing before receiving multiple clearances. Cleared for various sterilization cycles, these reliable trays give hospitals and healthcare facilities even more options when it comes to organizing, sterilizing, and protecting their instruments.

For the most up-to-date list of validated cycles, visit [www.instrusafe.com/validations](http://www.instrusafe.com/validations).



POINT CAMERA TO SEE VALIDATIONS



DECONTAMINATION
Instruments are individually protected going into the wash cycle and the trays are designed with large perforations, allowing detergent and water flow.
TRAY PREPARATION
Each tray is designed specifically for the instruments within it, providing individual locations for each one. This protects them from harming the technician, from damaging themselves and from puncturing or jeopardizing the integrity of the sterile barrier.
STERILIZATION
The large amount of perforations in our trays provide sterility penetration. Many of our silicone parts are also designed with minimal contact points.
TRANSPORTATION
Silicone holders in the base and cover secure instruments to prevent shifting and provide 360 degrees of protection. InstruSafe Trays help to avoid unnecessary damage and to present an organized instrument set every time.
OPERATING ROOM USE
Each instrument is easily identifiable and placed in its own position in the tray.

# Look Familiar?

Unfortunately, this is what most sterile processing departments have come to know. The familiarity and acceptance of these messy, hazardous baskets makes us cringe! Why, you ask? Because the minimal organization and protection of surgical instruments practiced in many facilities presents numerous risks to the individuals that come in contact with them, as well as to the instruments themselves.

# DISADVANTAGES OF MESSY BASKETS



- POTENTIAL TO COMPROMISE STERILE BARRIER BY POKING THROUGH WRAP □
- DANGEROUS TO TRANSPORT FROM THE O.R. TO THE SPD □
- MINIMAL INSTRUMENT PROTECTION AND ORGANIZATION □
- DIFFICULT TO COUNT AND TRACK INSTRUMENTS □
- BASKETS NEED FREQUENT REPLACEMENT □
- ADDS TIME TO SURGICAL SET-UP □
- BROKEN INSTRUMENTS IF DROPPED □
- HIGH RISK FOR FINGER POKES □
- POOR SURGICAL PRESENTATION □
- HARD TO FIND WHAT YOU NEED □
- MISSING/LOST INSTRUMENTS □
- UNNECESSARY REPROCESSING □
- DAMAGED INSTRUMENTS □
- WASTE OF SPACE □

## EXPECT MORE.

For these reasons and many more, InstruSafe Trays offer custom solutions to meet each customer's specific needs. We think it's time for everyone to expect more from their trays.

# Absolute Protection

## Trusted Solutions + Superior Results

Protection starts on the inside. Our comprehensive approach to maximizing instrument longevity is the focal point of our system. We paired our InstruSafe instrument protection trays and our container systems to deliver an unparalleled solution in surgical instrument care.



### QUARTER TURN LATCH

Secures the tray cover to the tray base, providing visual indication of the open/close position. Our off-set latch hole aligns the cover in the correct position ensuring the silicone holders match up with the instruments below.

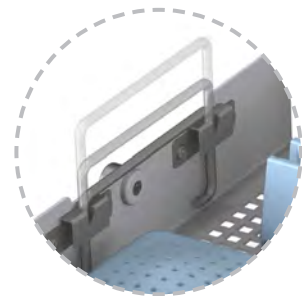

### RETRACTABLE HANDLES

Our multi-functional space-saving design fits into rigid containers making it effortless to remove the tray.

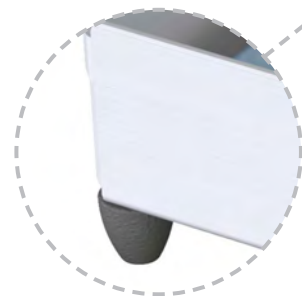

### TF FOOT

Our Tall Foot fits into rigid containers providing clearance for the filter in the base.

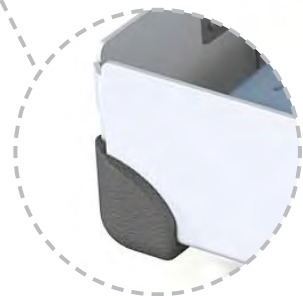

### R FOOT

Rounders Corner Guards help prevent tears in sterilization wrap during storage and transportation.

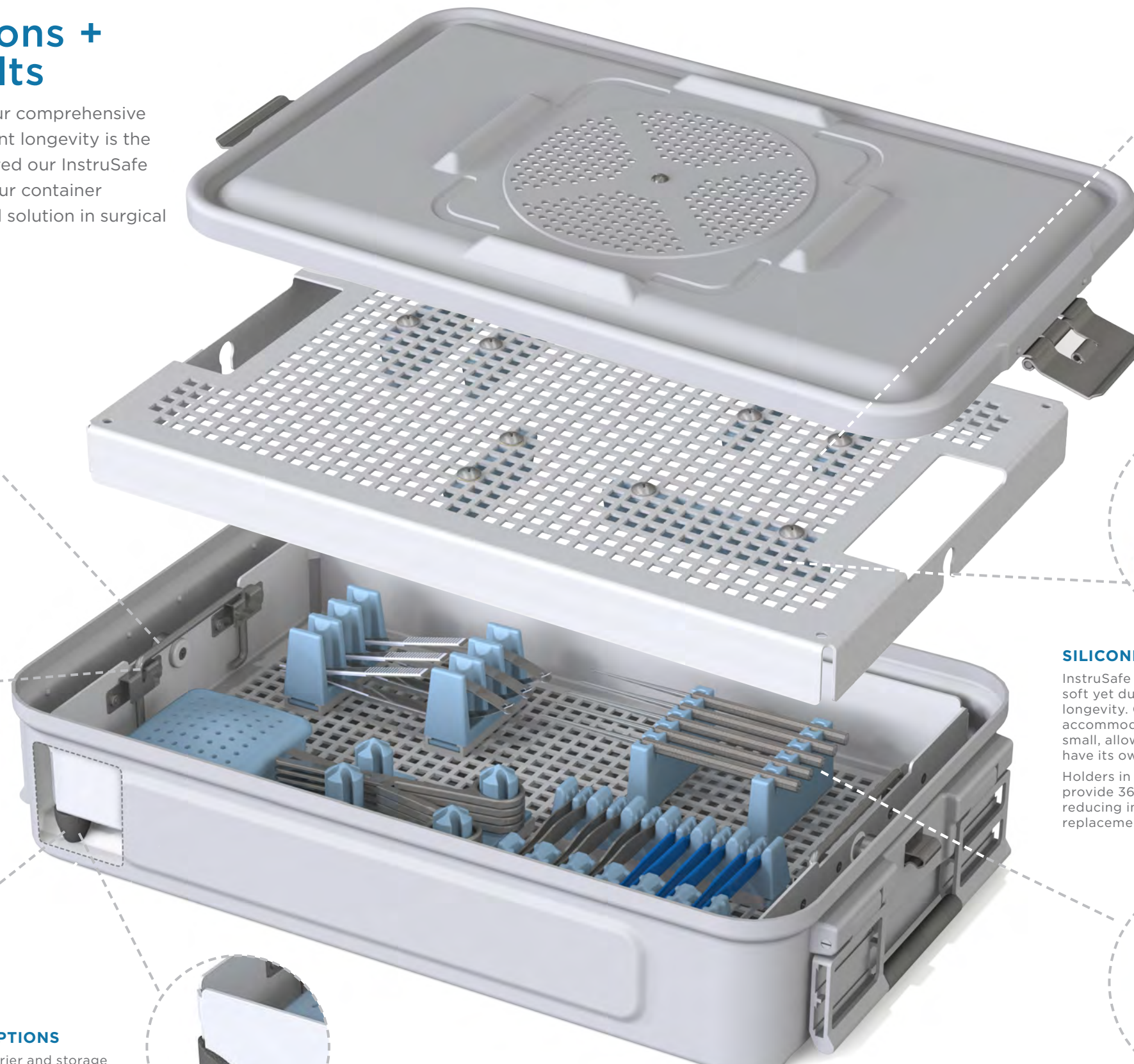

### PERFORATIONS (GRID PATTERN)

Each tray contains a large quantity of perforations that provide sterilant penetration and ventilation.



POINT CAMERA TO READ IFU

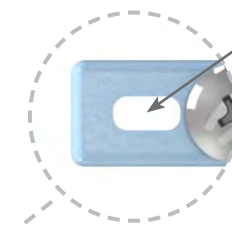

### VENTILATION

Our unique silicone design has channels that align with our perforations allowing detergent and sterilant to flow through the holder.

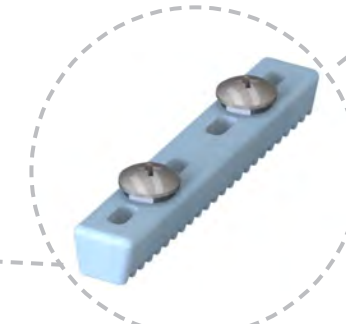

### SILICONE HOLDERS

InstruSafe silicone holders are soft yet durable, with a history of longevity. Our variety of holders accommodate instruments large or small, allowing each instrument to have its own location within the tray. Holders in the tray base and cover provide 360 degrees of protection reducing instrument repair and replacement.

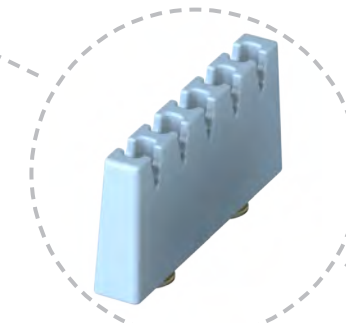
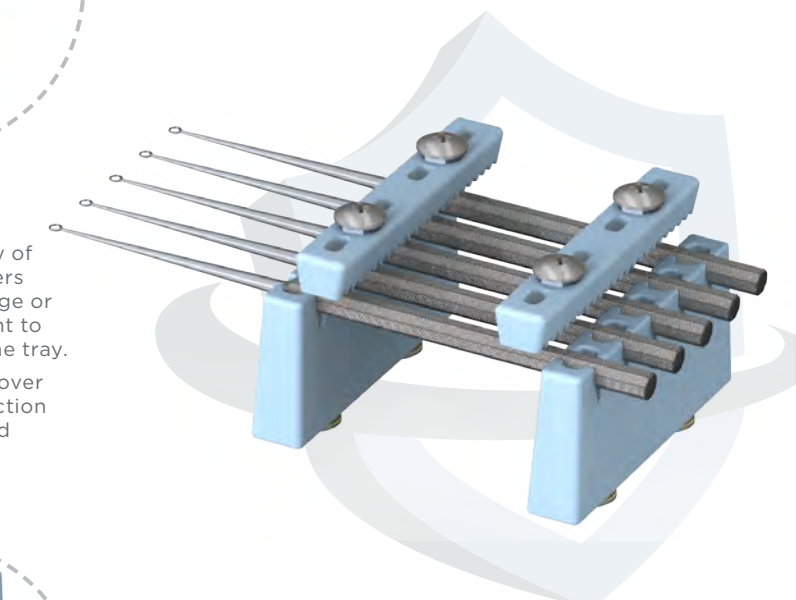

### REDUCED CONTACT POINTS

Each silicone holder is individually designed with ridges and channels built to reduce contact with the instrument while securely holding the instrument in place.

# 5 Simple Steps

If one of our preconfigured tray designs does not fit your needs let our product experts design a custom tray with our effortless process below.



## 1 ASSESS

An InstruSafe Representative conducts a free, on-site assessment of your instrument set.



## 2 GATHER

Your instrument set specifics and inputs are gathered by our team of experts.

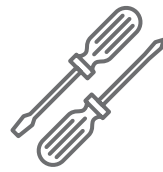

## 3 DESIGN

Using your inputs, our product specialists build a tray design with you and your instrument set in mind.



## 4 EVALUATE

You be the judge! Evaluate the new tray design while it's loaded with your instrument set. Let us know your thoughts and we will make any and all adjustments necessary!



## 5 COMPLETE

It's all yours! Once complete, each custom tray is assigned its own unique part number, making it simple and easy for you to reorder in future.

## HOW TO USE THE CATALOG

The colored headers identify which procedure the instrument set you're looking at is used for. The trays on each page are differentiated by preconfigured or custom configured with the symbols shown in the key below. Some trays have several layers including a cover, shelves, baskets, and a base. The custom configured tray examples included in the catalog are a small representation of the trays our local representatives have built for facilities around the world.

### CUSTOM + PRECONFIGURED SYMBOLS



#### THIS SYMBOL IDENTIFIES A PRECONFIGURED TRAY

Order by part number from your local InstruSafe representative or call us today.

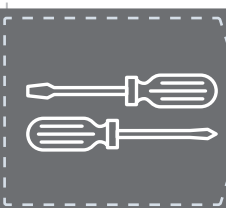

#### THIS SYMBOL IDENTIFIES A CUSTOM CONFIGURED TRAY EXAMPLE

Call us today to schedule your free assessment.

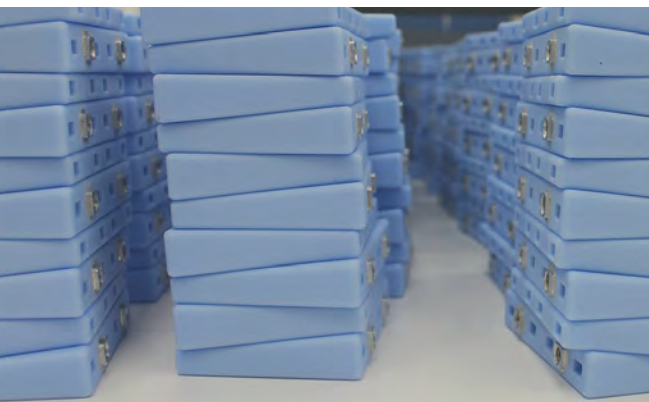

# Sterilization Barriers

InstruSafe Instrument Protection Trays are validated for several sterilization cycles using wrap and/or rigid containers.

For the most up-to-date list of Validated cleared cycles, visit [www.instrusafe.com](http://www.instrusafe.com).

# Foot Options

**R Foot:** Rounders Corner Guards—to be used with wrap

**TF Foot:** Tall Foot fits into rigid containers

# Rounders® Corner Guards

Rounded, medical grade corner guards affix to InstruSafe Tray corners to reduce potential damage to the sterile wrap barrier. Rounders are included with the purchase of designated tray orders, but can also be ordered at any time and easily added to all InstruSafe Trays.

# Tall Foot

Designed to affix to trays that are intended to be sterilized within a rigid container. Tall Feet are included with the purchase of designated tray orders, but can also be ordered at any time and easily added to most InstruSafe Trays.



ROUNDERS CORNER GUARDS	
KIT OF FOUR	IN-7334

- Kits can be purchased to upgrade existing trays
- Affix to tray with screws (included in kit)
- Designed to fit InstruSafe Trays
- Rounded, medical grade silicone corner guard
- Environmentally and economically efficient
- US Patent #9119611 | #D783856



TF FOOT KIT	
KIT OF FOUR	IN-7338

- Kits can be purchased to upgrade existing trays
- Affix to tray with screws (included in kit)
- Designed to fit InstruSafe Trays

## HOW TO ORDER:

EXAMPLE: TRAY IN-2890	
Wrapped Foot <b>IN-2890-R</b>	Container Foot <b>IN-2890-TF</b>

FOOT OPTION IS ADDED TO THE END OF THE PART NUMBER

## Preconfigured Tray for Arthroscopy

This three-level tray is equipped for both small and large arthroscopic instrument sets. Our tray is sized to fit most three-quarter size containers or can be wrapped for your convenience.

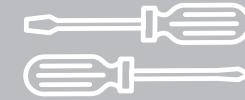

## Custom Configured Tray Example for Arthroscopy Example

- ARTHRO
- BARIATRIC
- CARDIO
- DENTAL
- ENT
- GENERAL
- GYN
- NEURO
- EYE
- ORTHO
- PLASTICS
- RETRACTORS
- SCOPES
- ROBOTICS
- ACCESSORIES
- TRANSPORT CONTAINERS

- ARTHRO
- BARIATRIC
- CARDIO
- DENTAL
- ENT
- GENERAL
- GYN
- NEURO
- EYE
- ORTHO
- PLASTICS
- RETRACTORS
- SCOPES
- ROBOTICS
- ACCESSORIES
- TRANSPORT CONTAINERS

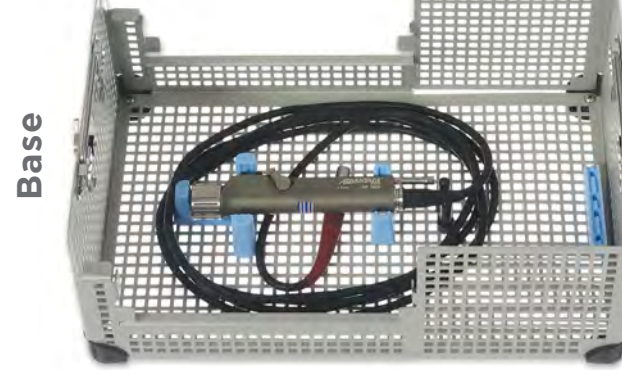
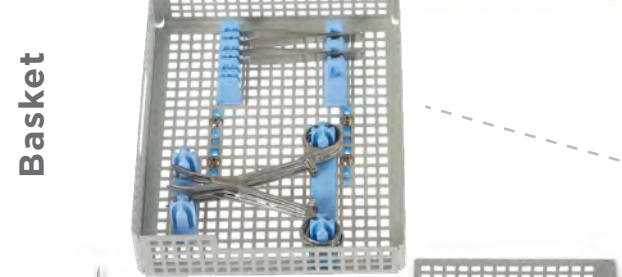
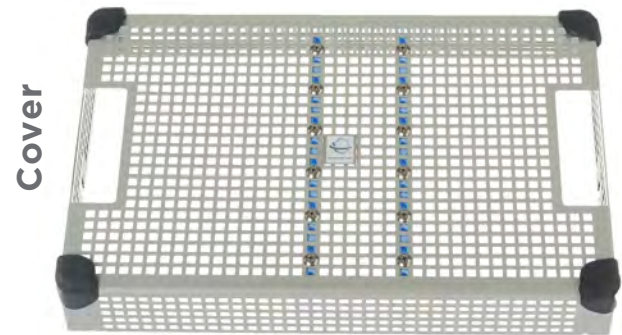

ARTHROSCOPY TRAY	
Holds: A combination of up to 12 of the following instruments:	
<ul style="list-style-type: none"> <li>• Punches</li> <li>• Ring Handle Instruments</li> <li>• Other Associated Endoscopic Instruments</li> </ul>	<ul style="list-style-type: none"> <li>• Rongeurs</li> <li>• Graspers</li> </ul>
15 ¼ L x 9 ⅝ W x 5 ¾ H (in)	387 L x 244 W x 146 H (mm)
Wrapped Foot IN-2846-R	Container Foot IN-2846-TF

Expand capacity with positionable Hold-Its™ and Hold-Downs™ silicone instrument holders. Multi-level to accommodate a high quantity of instruments.

**CUSTOM CONFIGURED**  
Silicone in basket and base can be customized to accommodate specific instrumentation. Silicone in image is for illustrative purposes only.

**CALL US TODAY FOR CUSTOMIZATION!**

### ARTHROSCOPY TMJ TRAY | 17 INSTRUMENTS

**BEFORE**



**CUSTOM CONFIGURED**

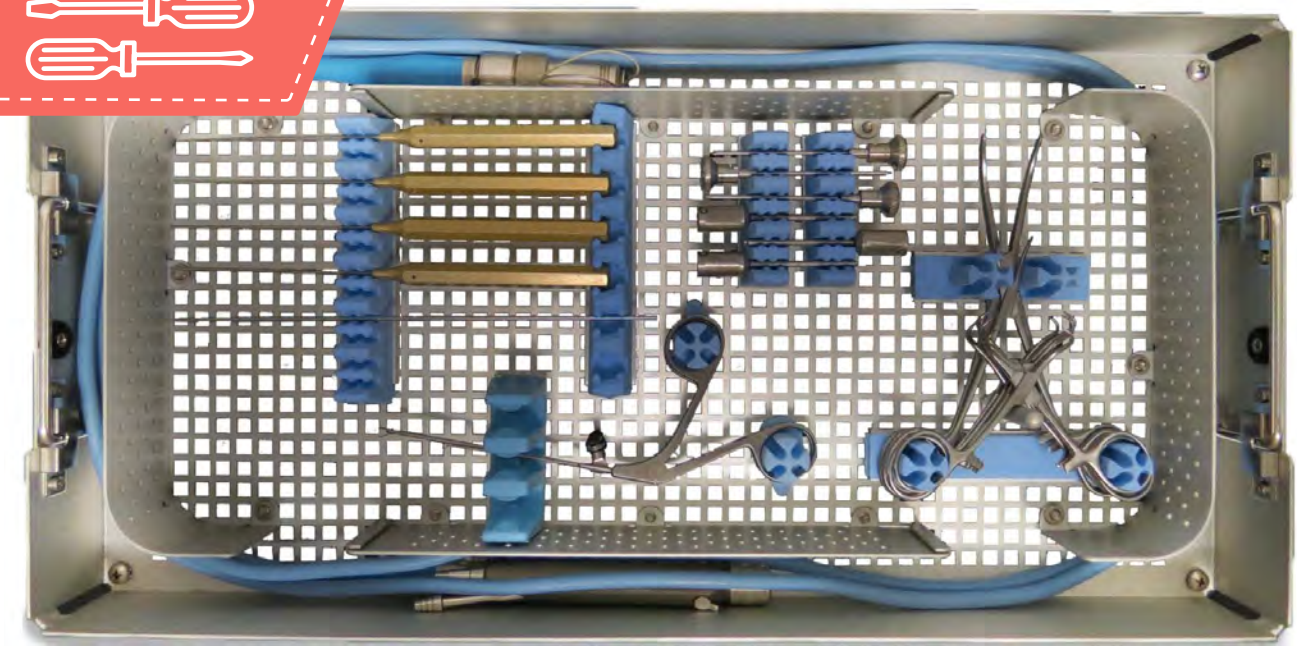

**AFTER**

Tray shown without cover for illustrative purposes. All custom InstruSafe Trays come with a cover to provide 360 degrees of protection.



## Preconfigured Tray for Bariatric

The bariatric tray is designed to accommodate some of the longest instruments. Our three-level system allows you to get organized and protect all of your bariatric instrumentation in one tray.

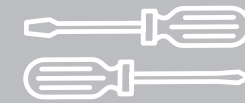

## Custom Configured Tray Example for Bariatric

### BARIATRIC LAPAROSCOPIC SET | 59 INSTRUMENTS



BARIATRIC TRAY	
Holds: A combination of up to 15 (32cm to 45cm+) of the following instruments:	
<ul style="list-style-type: none"> <li>Laparoscopic Instruments</li> <li>General Dissecting Instruments</li> <li>Miscellaneous Parts</li> <li>Tubing/Cords</li> </ul>	<ul style="list-style-type: none"> <li>Cannulas</li> <li>Sheaths</li> <li>Trocars</li> </ul>
28 L x 13 W x 8 H (in)	711 L x 330 W x 203 H (mm)
Wrapped Foot IN-8864-R	Container Foot IN-8864-TF

Expand capacity with positionable Hold-Its™ and Hold-Downs™ silicone instrument holders.  
Multi-level to accommodate a high quantity of instruments.

**CALL US TODAY FOR CUSTOMIZATION!**

### CUSTOM CONFIGURED BARIATRIC TRAY | 31 INSTRUMENTS

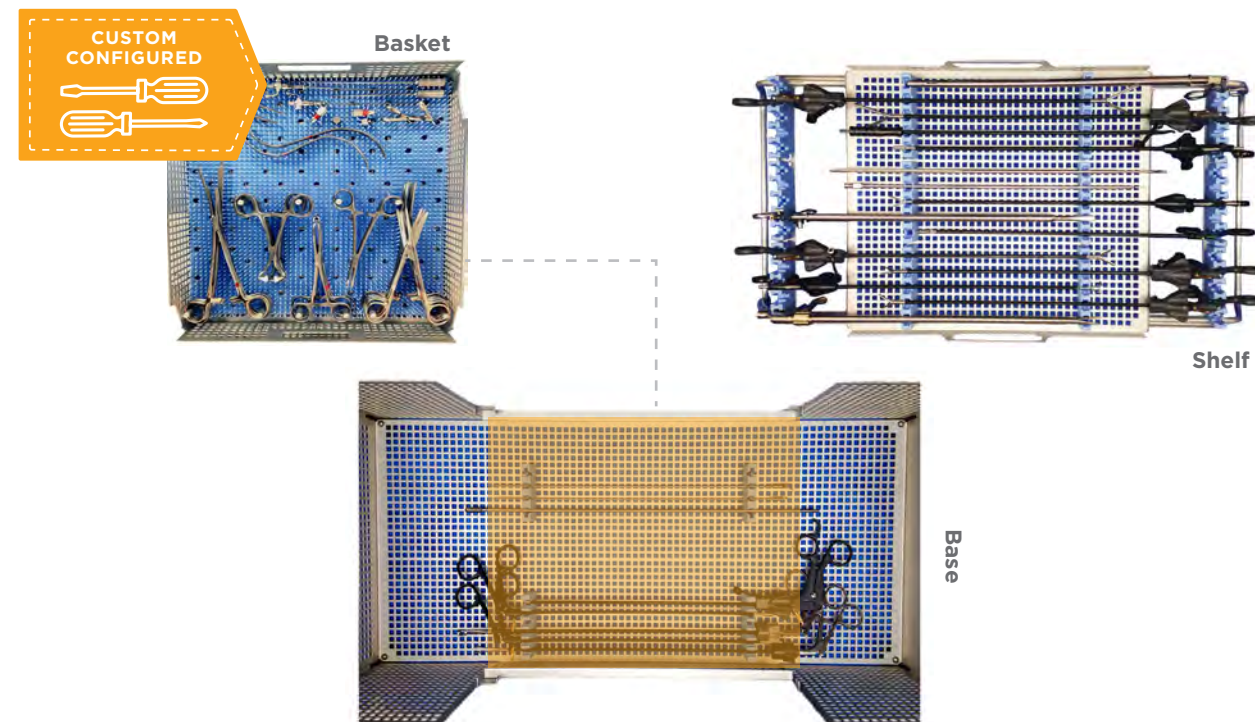

## BEFORE

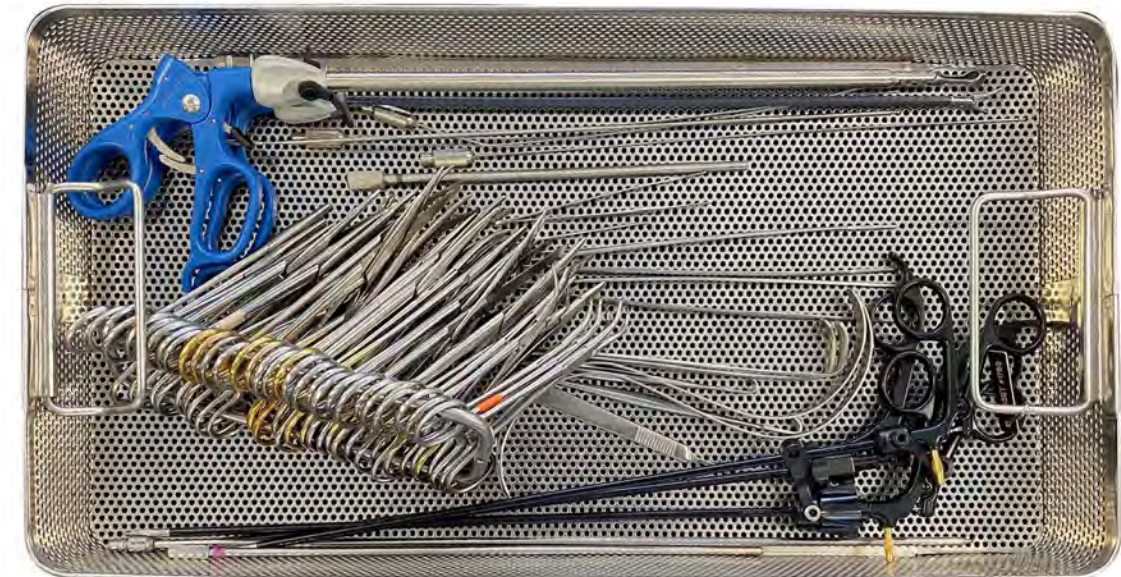

## CUSTOM CONFIGURED

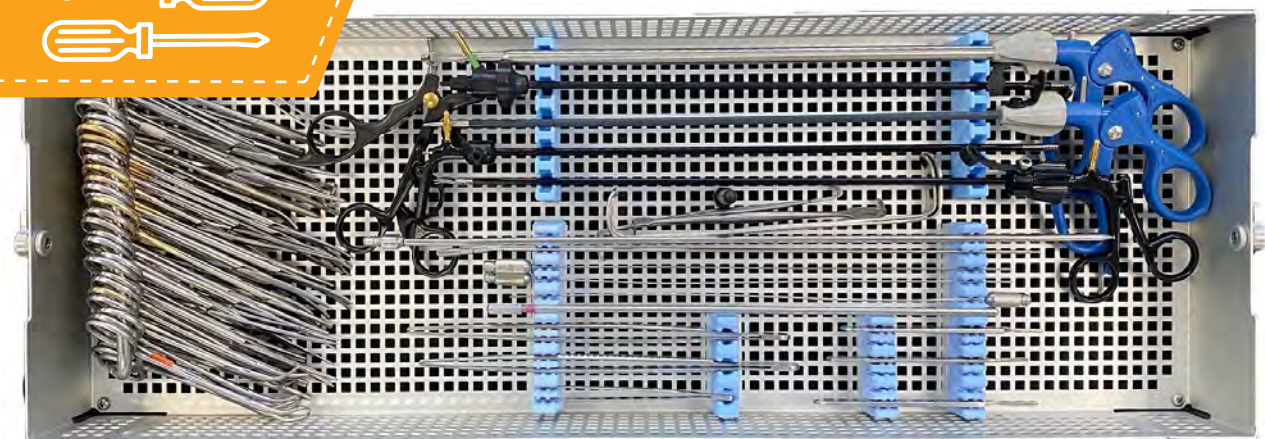

## AFTER

Tray shown without cover for illustrative purposes. All custom InstruSafe Trays come with a cover to provide 360 degrees of protection.

Tray shown without cover for illustrative purposes. All custom InstruSafe Trays come with a cover to provide 360 degrees of protection.



## Preconfigured Tray Example for Cardiovascular

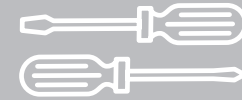

## Custom Configured Tray Example for Cardiovascular

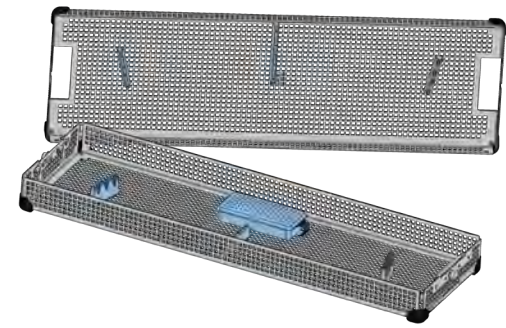

VASCULAR TUNELER TRAY	
Holds: • 1 Vascular Tuner • 2 Tubes (6mm + 8mm) • Bullet Tips	
31 7/8 L x 9 5/8 W x 2 3/8 H (in)	810 L x 244 W x 60 H (mm)
Wrapped Foot IN-5030-R	Container Foot IN-5030-TF

### MICROVASCULAR SET | 19 INSTRUMENTS

## BEFORE

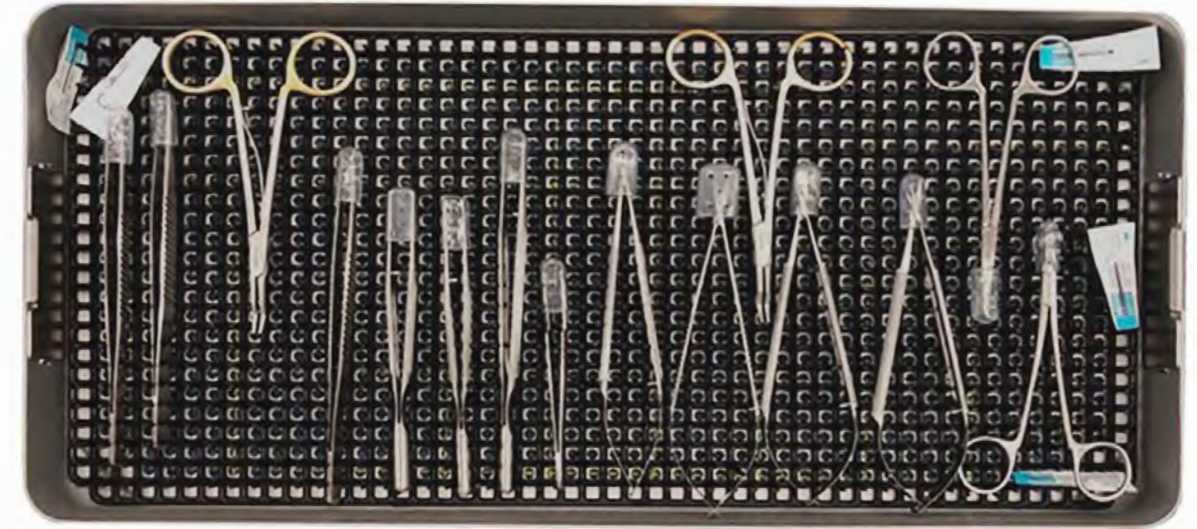

## CUSTOM CONFIGURED

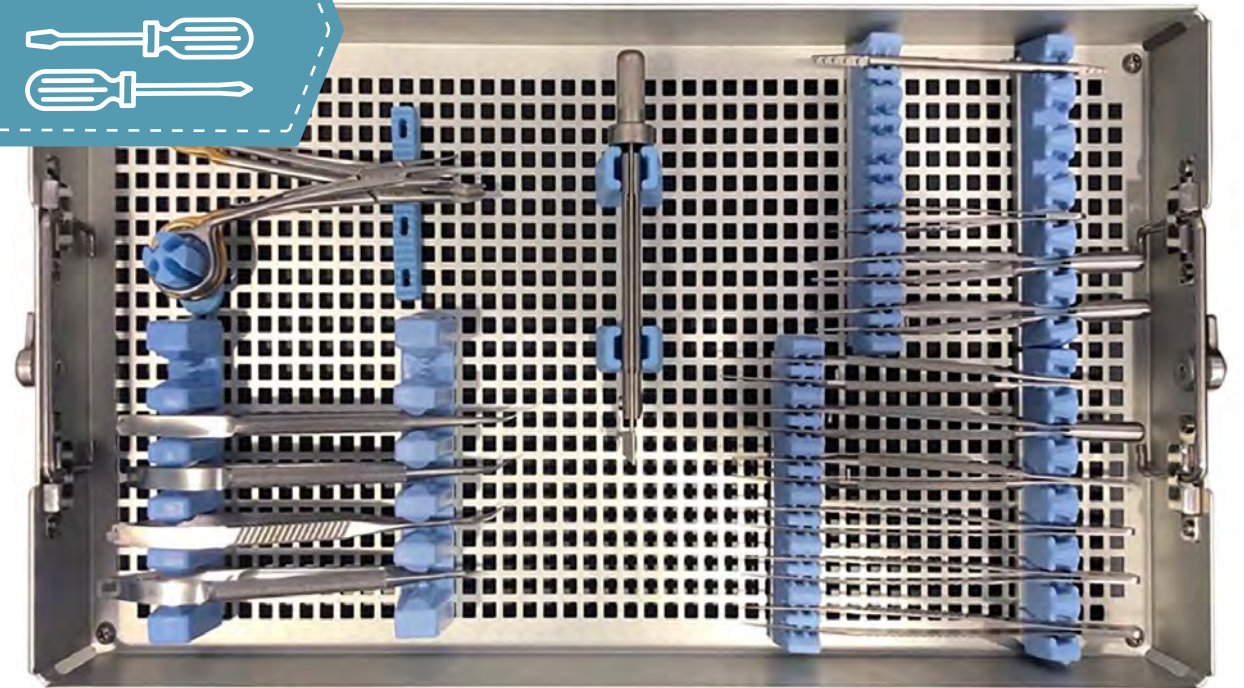

## AFTER

Tray shown without cover for illustrative purposes. All custom InstruSafe Trays come with a cover to provide 360 degrees of protection.

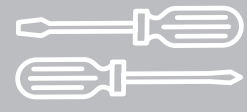

Custom Configured Tray Example for  
**Cardiovascular**

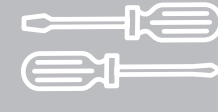

Custom Configured Tray Example for  
**Dental**

EVANS ROTATABLE TRAY | 32 INSTRUMENTS

DENTAL SET | 34 INSTRUMENTS

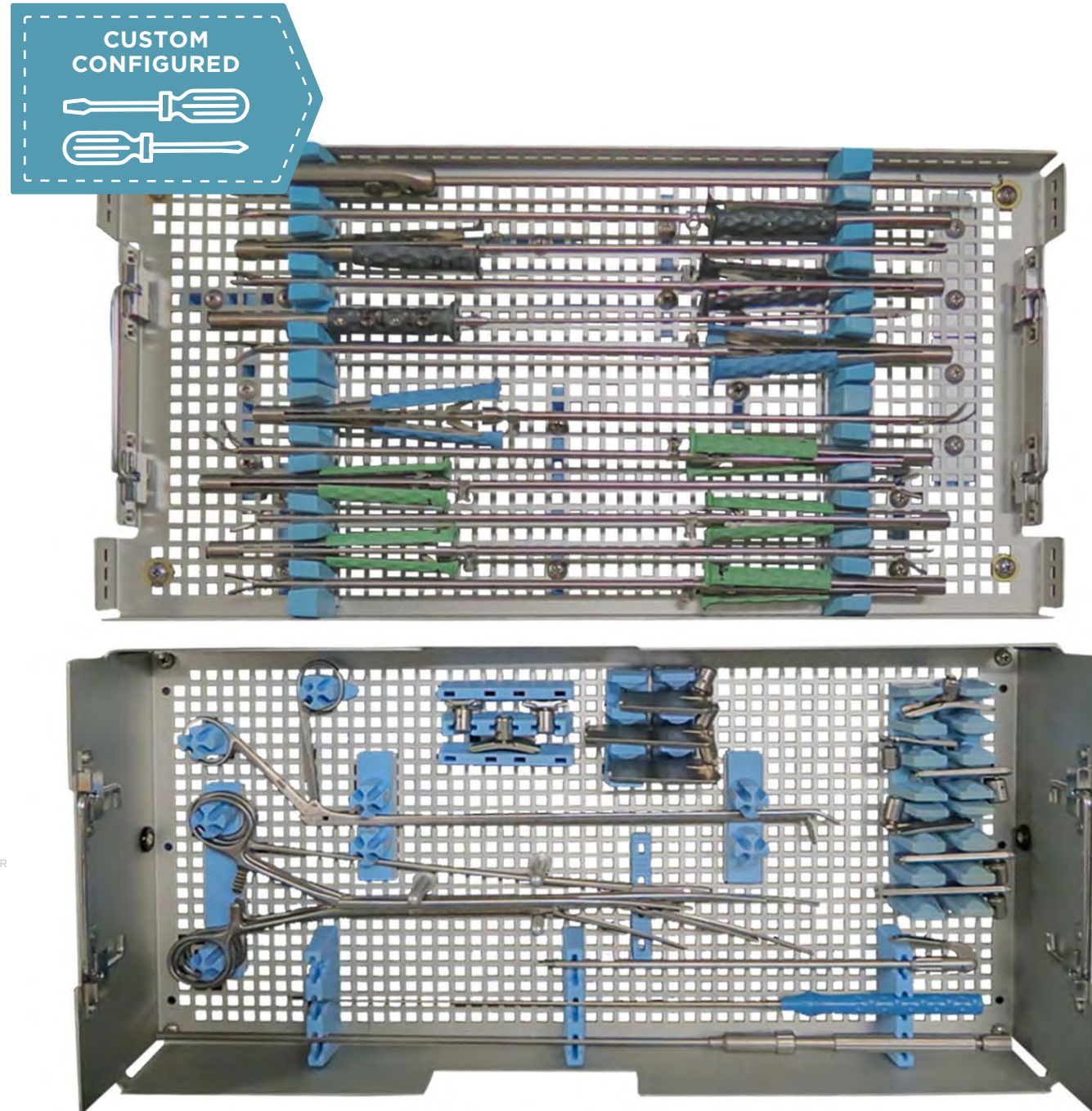

Shelf

Base

**BEFORE**

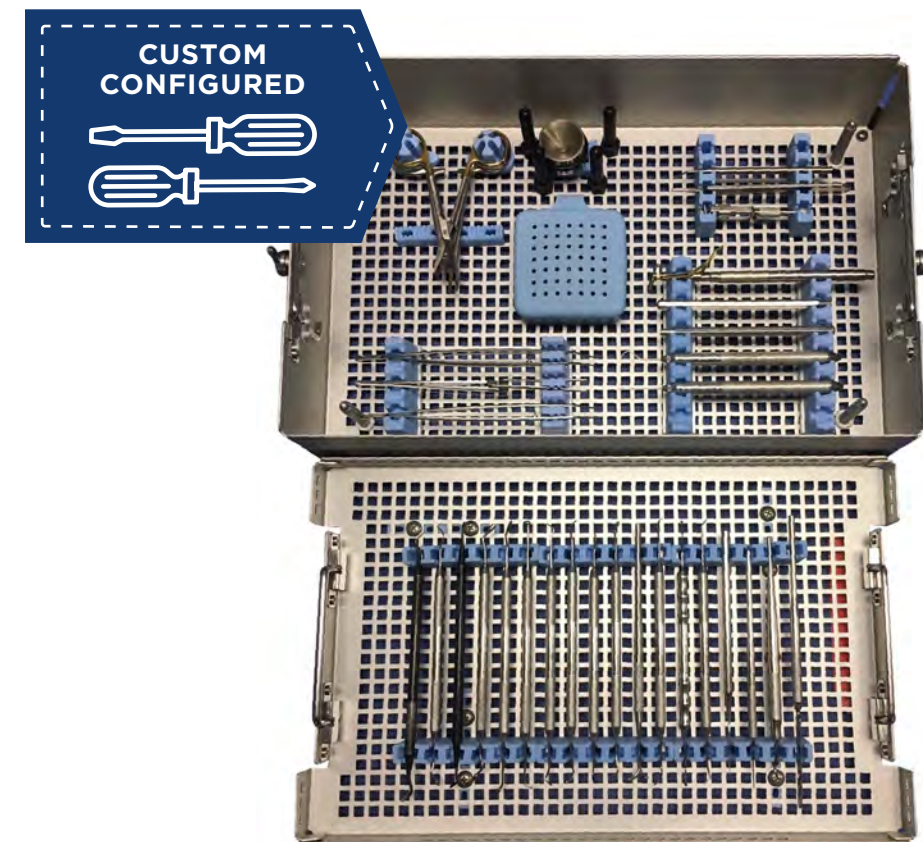
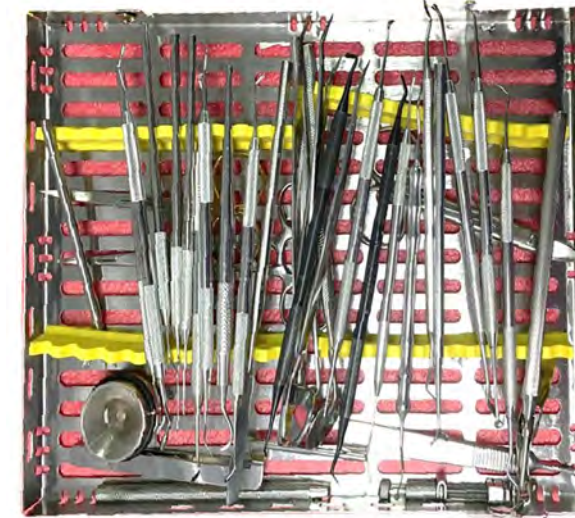

**AFTER**

Tray shown without cover for illustrative purposes. All custom InstruSafe Trays come with a cover to provide 360 degrees of protection.

Tray shown without cover for illustrative purposes. All custom InstruSafe Trays come with a cover to provide 360 degrees of protection.

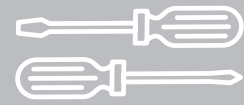

### Custom Configured Tray Example for Dental

#### OPERATIVE TRAY SET | 11 INSTRUMENTS

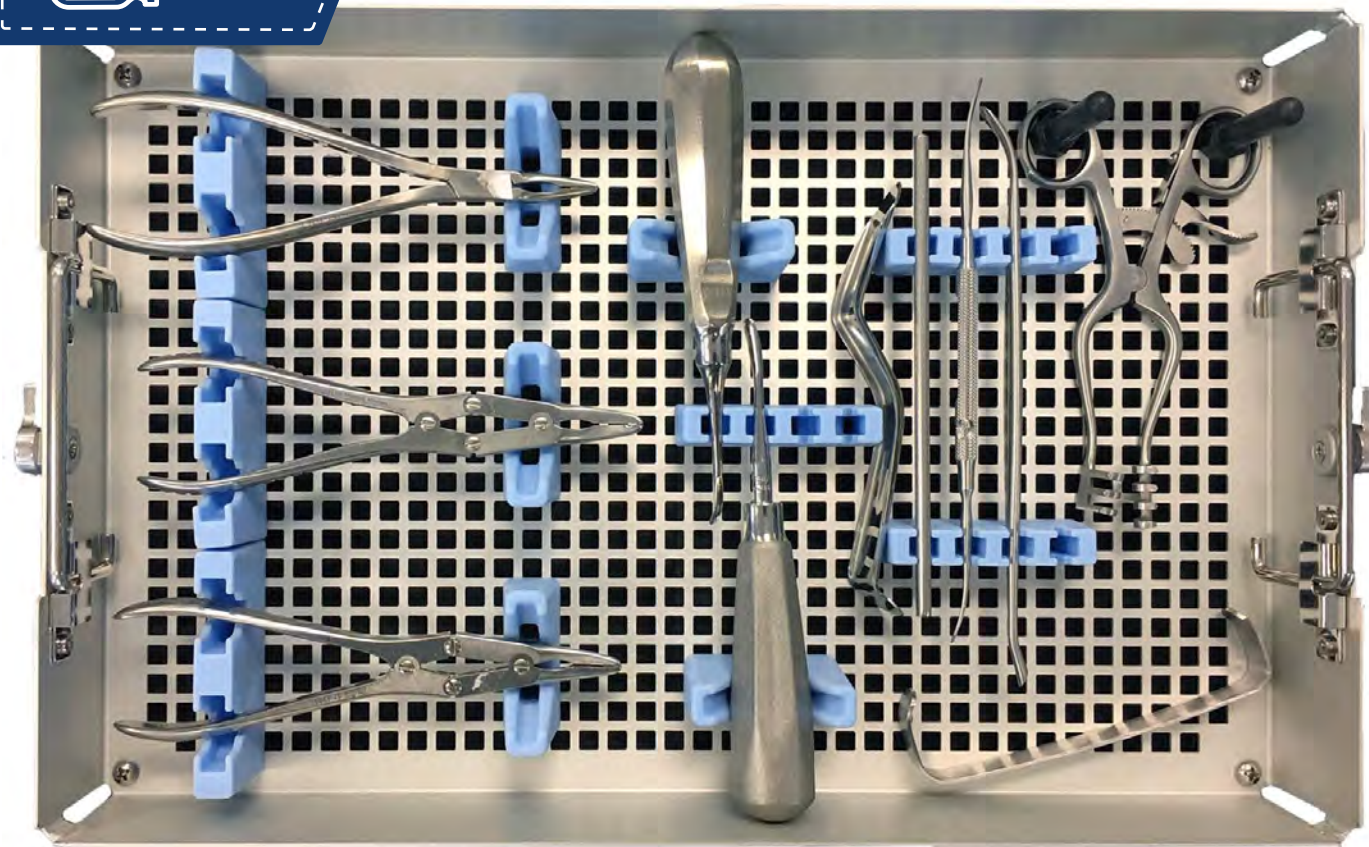
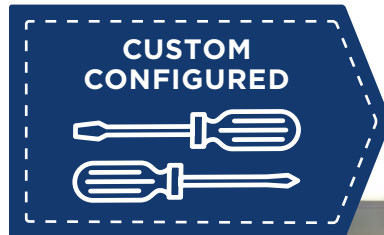

# ENT SYSTEMS

Since the mid-1980's, we have offered a complete solution for fine and delicate ear instrumentation through our Middle Ear System. We are proud to claim this as our very first InstruSafe product. Our modules are designed to specifically fit each instrument and can be used individually or in combination, to organize and protect an entire instrument set.

*MIX AND MATCH OUR MODULES FROM PAGES 22-23 TO FIT YOUR INSTRUMENT SET, CREATING YOUR UNIQUE ENT SYSTEM!*

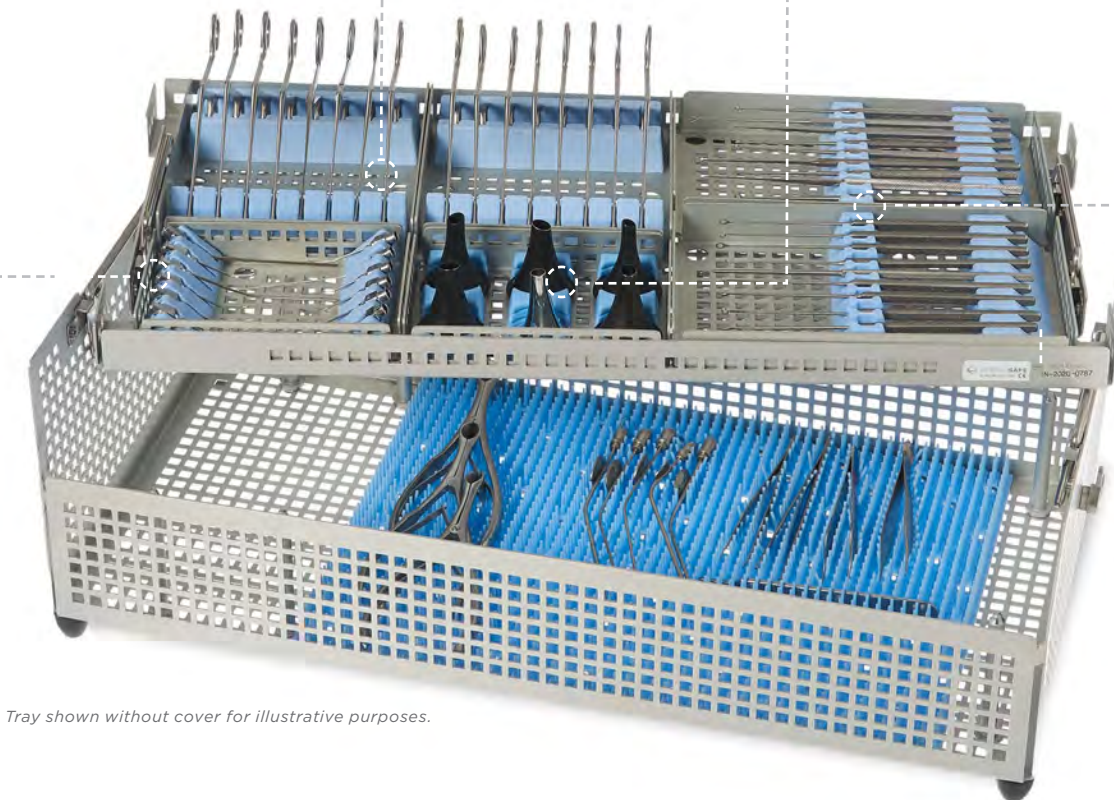
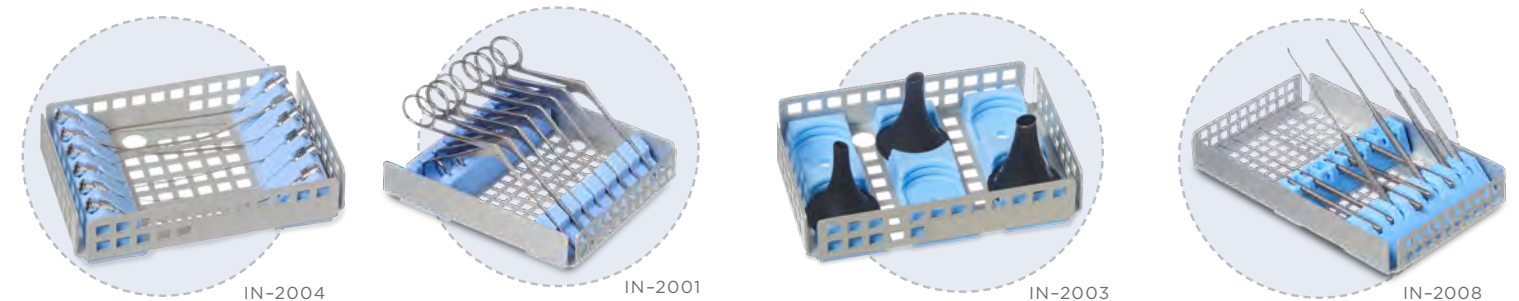

Tray shown without cover for illustrative purposes.

Tray shown without cover for illustrative purposes. All custom InstruSafe Trays come with a cover to provide 360 degrees of protection.



## Preconfigured Trays for ENT Modules



## Preconfigured Trays for ENT Modules

ARTHRO  
BARIATRIC  
CARDIO  
DENTAL  
ENT  
GENERAL  
GYN  
NEURO  
EYE  
ORTHO  
PLASTICS  
RETRACTORS  
SCOPES  
ROBOTICS  
ACCESSORIES  
TRANSPORT CONTAINERS

ARTHRO  
BARIATRIC  
CARDIO  
DENTAL  
ENT  
GENERAL  
GYN  
NEURO  
EYE  
ORTHO  
PLASTICS  
RETRACTORS  
SCOPES  
ROBOTICS  
ACCESSORIES  
TRANSPORT CONTAINERS



MIDDLE EAR TRAY	
Holds: • 2 Alligator Forcep Modules • 1 Speculum Module • 2 Pick + Hook Modules • 9½ x 13" Finger Mat • 1 Micro-Suction Module	
19 ½ L x 9 ¾ W x 6 H (in)	498 L x 244 W x 152 H (mm)
Wrapped Foot IN-2890-R	Container Foot IN-2890-TF



MIRCO SUCTION MODULE	
Holds: • 12 Micro-Suction Irrigators with Luer Lock Hubs	
5 ½ L x 3 ½ W x 1 H (in)	130 L x 89 W x 25 H (mm)
IN-2004	



ALLIGATOR MODULE	
Holds: • 8 Alligator Style Instruments (Cup, Scissors, etc.)	
5 ¾ L x 5 ½ W x 1 H (in)	149 L x 130 W x 25 H (mm)
IN-2001	



SUCTION MODULE	
Holds: • 10 Ferguson Style Suctions	
3 ½ L x 5 ½ W x 1 H (in)	89 L x 130 W x 25 H (mm)
IN-2005	



PICK + HOOK MODULE, 10 POSITION	
Holds: • 10 Small Handle Picks, Hooks, Dissectors or Curettes	
7 ¾ L x 5 ½ W x 1 H (in)	194 L x 130 W x 25 H (mm)
IN-2002	



ALLIGATOR MODULE WITH COVER	
Holds: • 8 Alligator Style Instruments (Cup, Scissors, etc.)	
7 ¾ L x 5 ½ W x 3 H (in)	194 L x 130 W x 76 H (mm)
IN-2006	



SPECULUM MODULE	
Holds: • 6-12 Speculas	
3 ½ L x 5 ½ W x 1 H (in)	89 L x 130 W x 25 H (mm)
IN-2003	



PICK + HOOK MODULE, 9 POSITION	
Holds: • 9 Small Handle Picks, Hooks, Dissectors or Curettes	
7 ¾ L x 4 ¾ W x 1 H (in)	194 L x 117 W x 25 H (mm)
IN-2008	



## Preconfigured Trays for Picks + Hooks

Similar to our original module designs, these standalone trays will protect and organize pick, hook and knife instrumentation for ENT procedures. Instruments can either be positioned at a 45 degree angle for procedural presentation or secured flat for sterilization and storage.

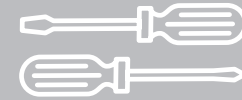

## Custom Configured Tray Example for Ear

ARTHRO  
BARIATRIC  
CARDIO  
DENTAL  
ENT  
GENERAL  
GYN  
NEURO  
EYE  
ORTHO  
PLASTICS  
RETRACTORS  
SCOPES  
ROBOTICS  
ACCESSORIES  
TRANSPORT CONTAINERS

ARTHRO  
BARIATRIC  
CARDIO  
DENTAL  
ENT  
GENERAL  
GYN  
NEURO  
EYE  
ORTHO  
PLASTICS  
RETRACTORS  
SCOPES  
ROBOTICS  
ACCESSORIES  
TRANSPORT CONTAINERS



10 PICK + HOOK WITH COVER	
Holds: • 10 Pick + Hook Style Instruments	
5 ¼ L x 8 ¾ W x 1 ½ H (in)	133 L x 222 W x 38 H (mm)
IN-4010	



20 PICK + HOOK WITH COVER	
Holds: • 20 Pick + Hook Style Instruments	
11 L x 8 ¾ W x 1 ½ H (in)	279 L x 222 W x 38 H (mm)
IN-4000	

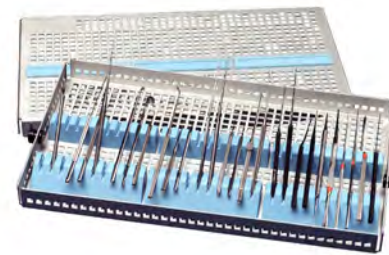

30 PICK + HOOK WITH COVER	
Holds: • 30 Pick + Hook Style Instruments	
15 L x 8 ¾ W x 1 ½ H (in)	381 L x 222 W x 38 H (mm)
IN-4003	

### MYRINGOTOMY SET | 26 INSTRUMENTS

**BEFORE**

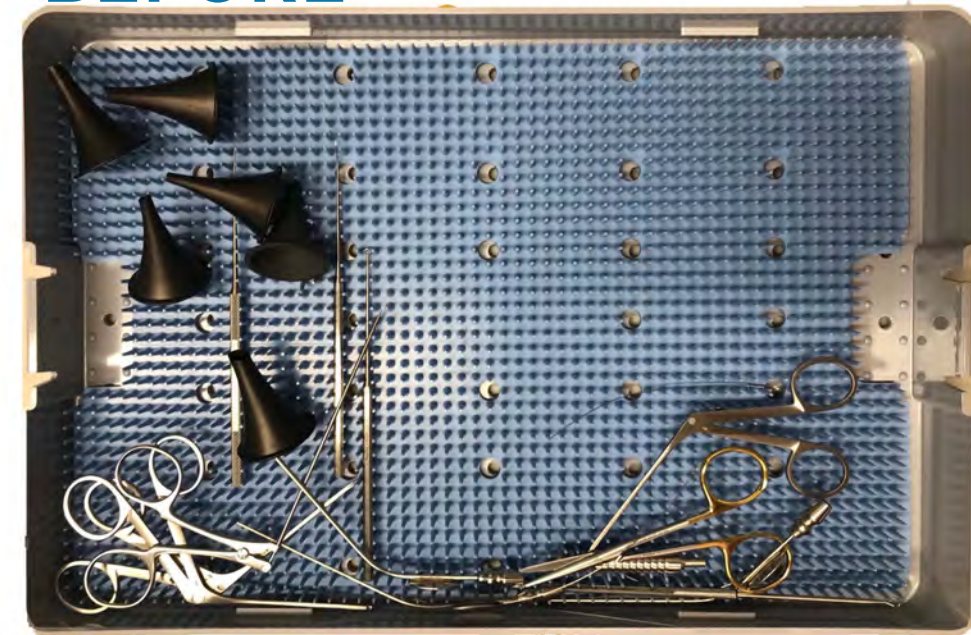

**CUSTOM CONFIGURED**

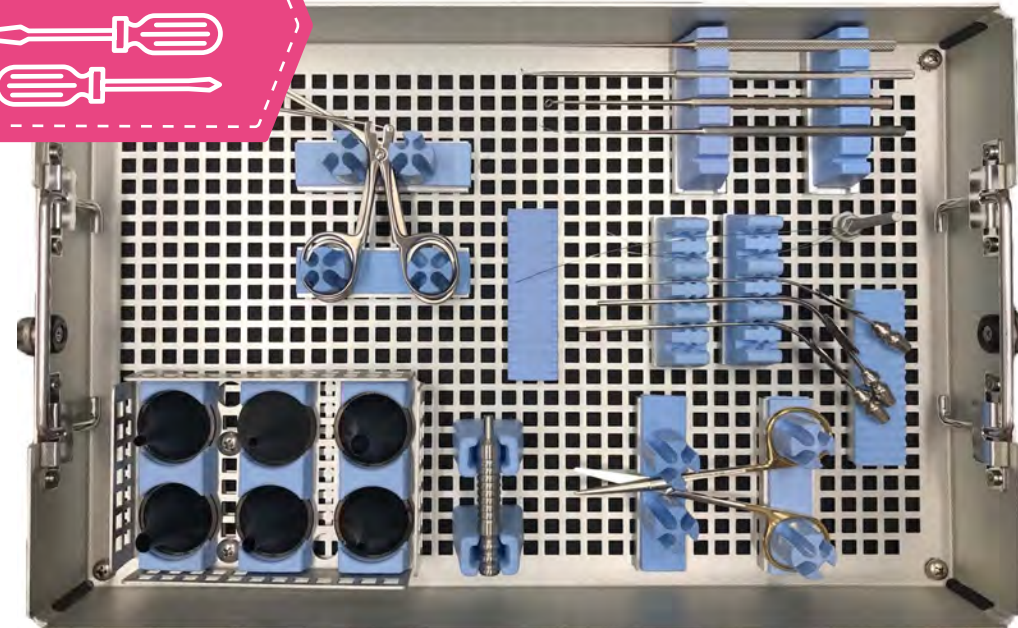
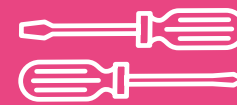

**AFTER**

Tray shown without cover for illustrative purposes. All custom InstruSafe Trays come with a cover to provide 360 degrees of protection.

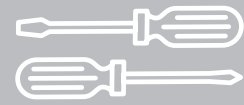

### Custom Configured Tray Example for Ear

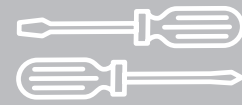

### Custom Configured Tray Example for Ear

#### EAR TRAY | 86 INSTRUMENTS

#### MAJOR EAR TRAY | 66 INSTRUMENTS

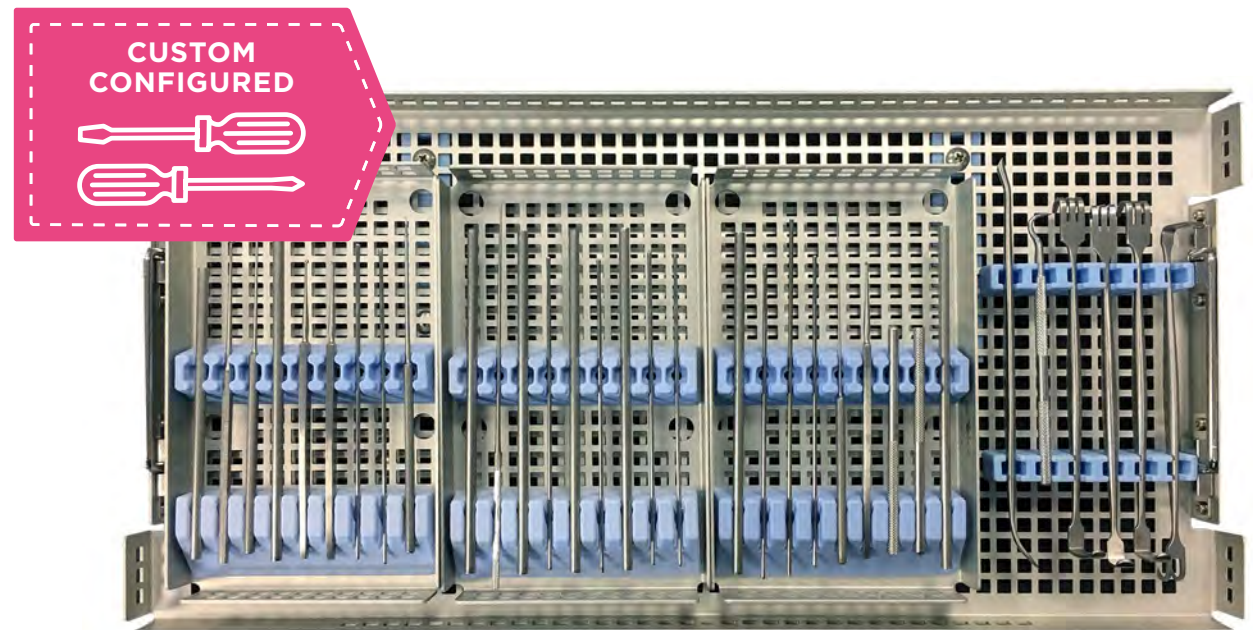
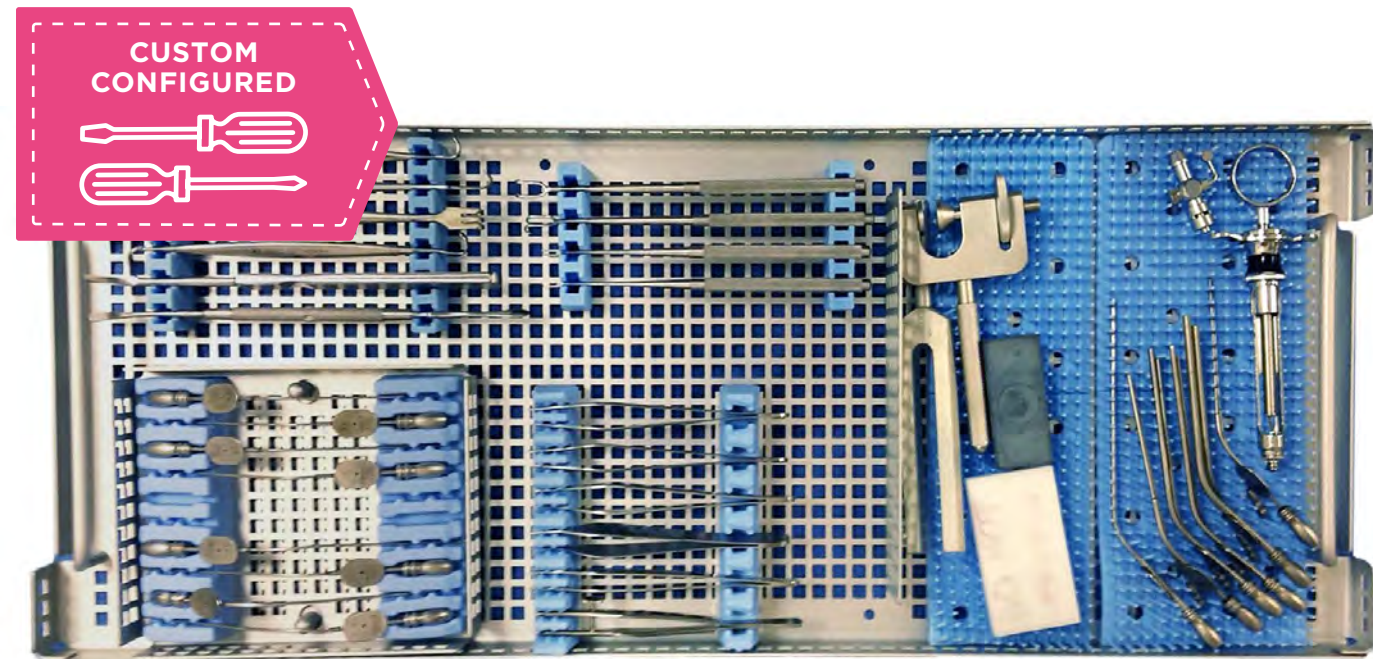

Shelf

Shelf

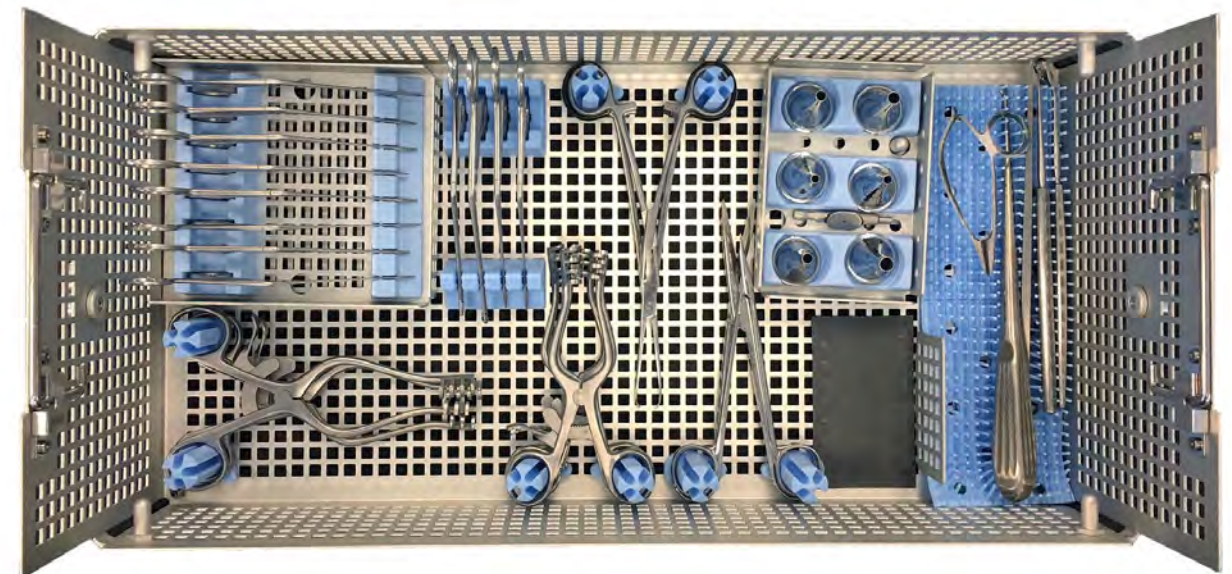
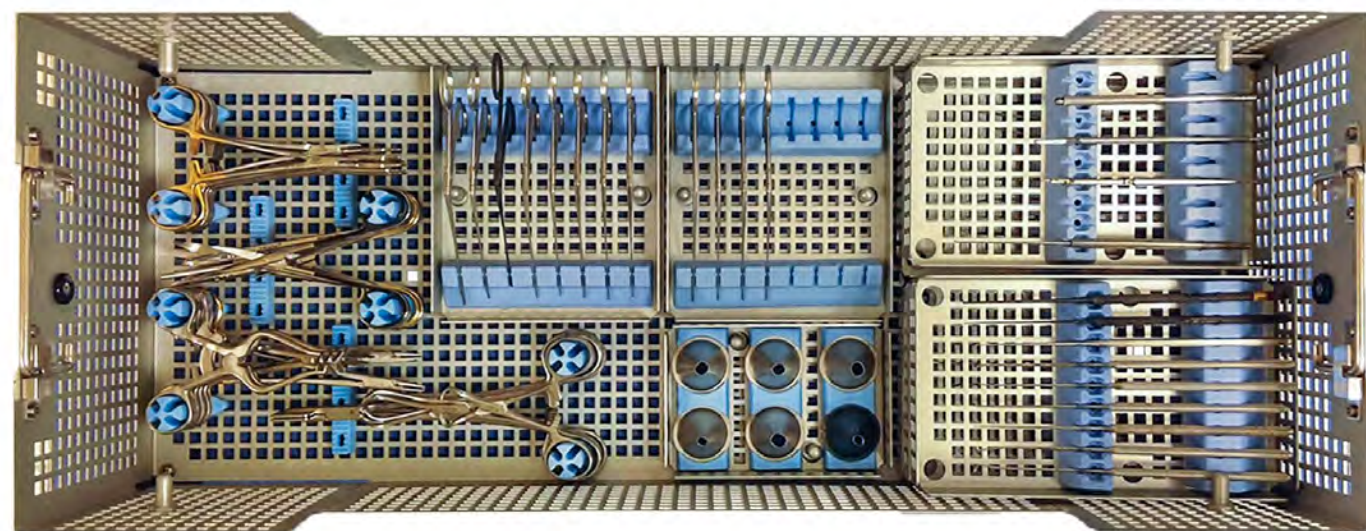

Base

Base

Tray shown without cover for illustrative purposes. All custom InstruSafe Trays come with a cover to provide 360 degrees of protection.

Tray shown without cover for illustrative purposes. All custom InstruSafe Trays come with a cover to provide 360 degrees of protection.



### Preconfigured Tray for Nose/Sinus

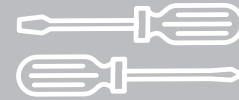

### Custom Configured Tray Example for Nose/Sinus



#### ENDOSCOPY SINUS TRAY

Holds:  
A combination of up to 12 of the following instruments:

- Punches
- Ring Handle Instruments
- Other Associated Endoscopic Instruments
- Rongeurs
- Graspers

15 ¼ L x 9 ⅝ W x 5 ¾ H (in)	387 L x 244 W x 146 H (mm)
Wrapped Foot IN-2846-R	Container Foot IN-2846-TF

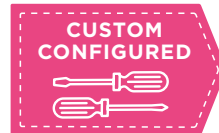

Silicone in basket and base can be customized to accommodate specific instrumentation. Silicone in image is for illustrative purposes only.

**CALL US TODAY FOR CUSTOMIZATION!**

#### SINUS SET | 32 INSTRUMENTS

## BEFORE

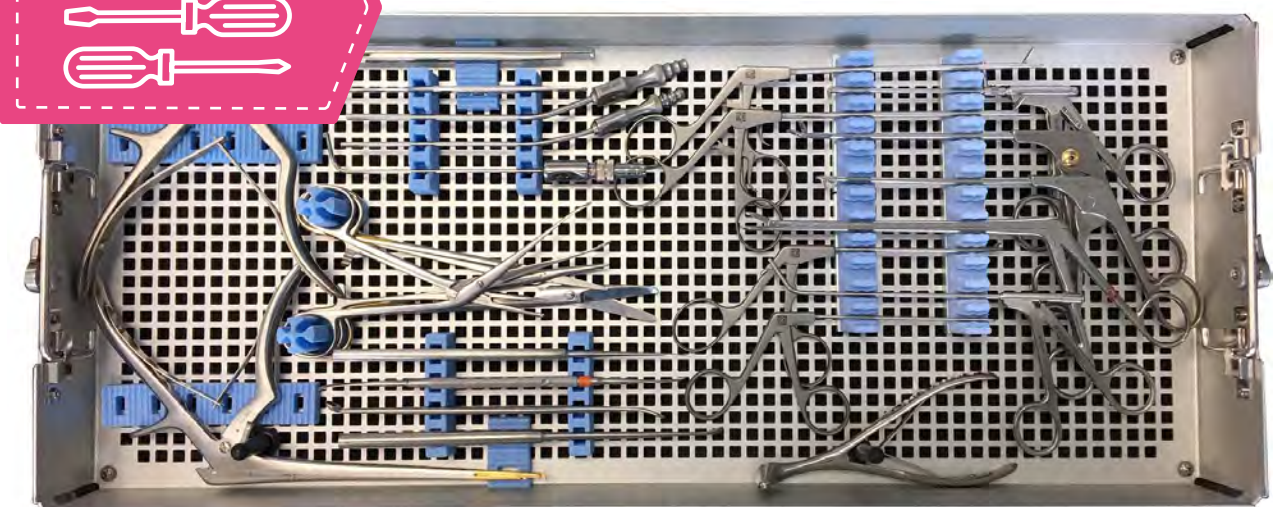
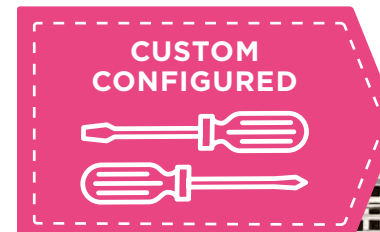
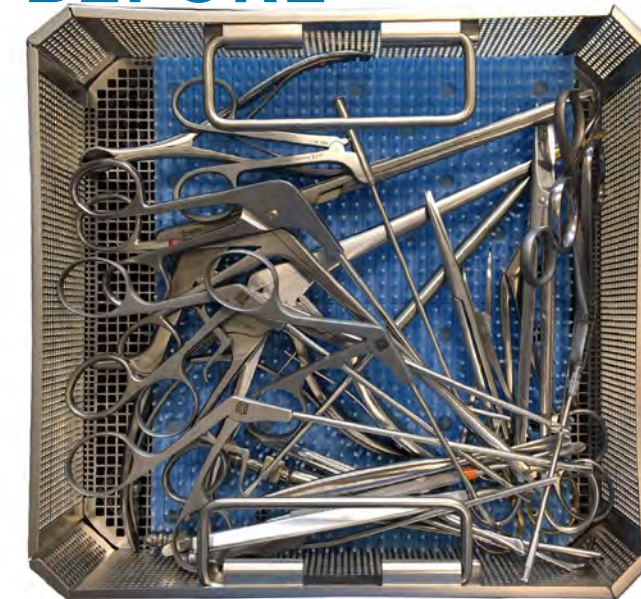

## AFTER

*Tray shown without cover for illustrative purposes. All custom InstruSafe Trays come with a cover to provide 360 degrees of protection.*

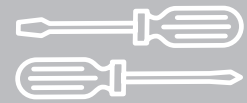

### Custom Configured Tray Example for Nose/Sinus



### Preconfigured Tray for Throat

#### SINUS TRAY | 34 INSTRUMENTS

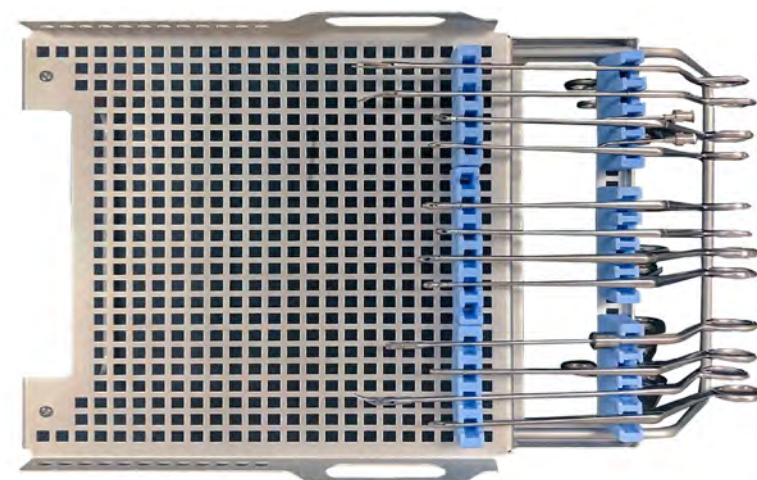
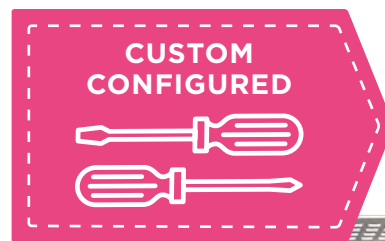

Shelf

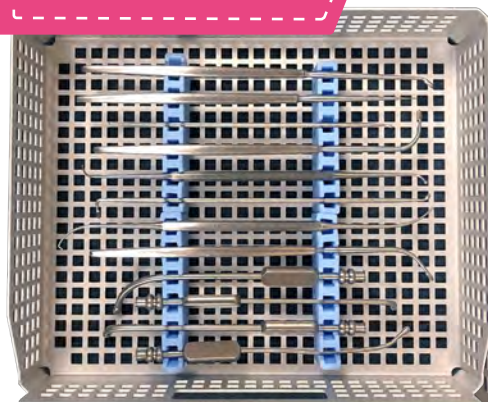

Basket

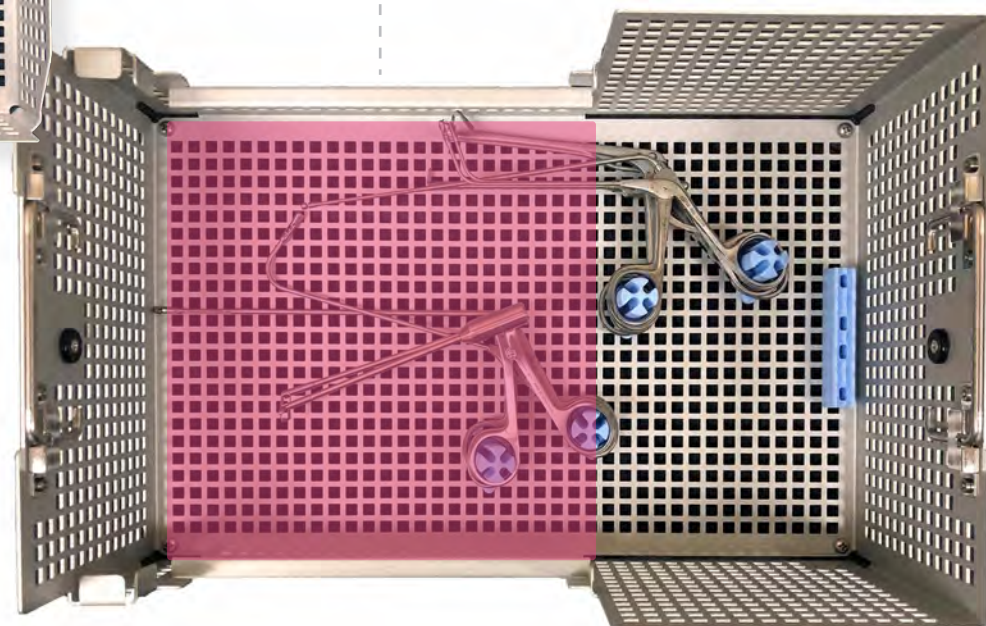

Base

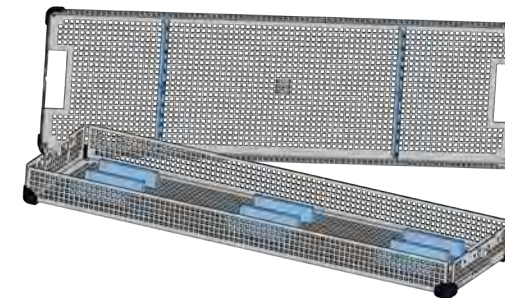

ESOPHOGEAL DILATOR TRAY	
Holds: • 6-16 dilators of varying diameters	
31 7/8 L x 9 5/8 W x 2 3/8 H (in)	810 L x 244 W x 60 H (mm)
Wrapped Foot IN-5040-R	Container Foot IN-5040-TF

Tray shown without cover for illustrative purposes. All custom InstruSafe Trays come with a cover to provide 360 degrees of protection.



### Preconfigured Tray for Throat

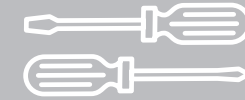

### Custom Configured Tray Example for Throat

Cover

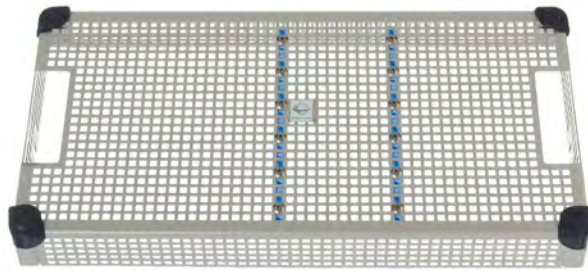

FULL SIZE ENDOSCOPY TRAY	
Holds: • 14 Endoscopy Style Instruments	
19 5/8 L x 9 5/8 W x 7 H (in)	498 L x 244 W x 178 H (mm)
Wrapped Foot IN-2847-R	Container Foot IN-2847-TF

Shelf



Basket

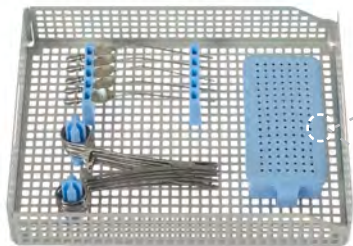

Base

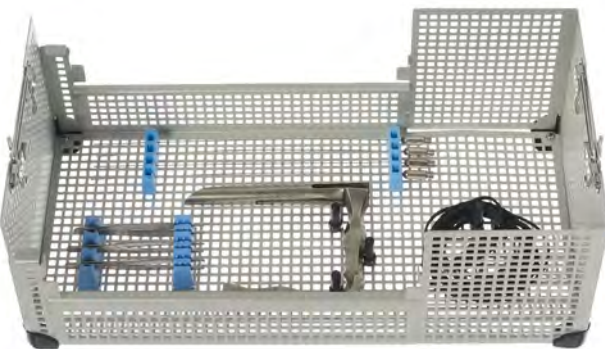

Small Parts Boxes are perfect for your small delicate instruments or accessories.

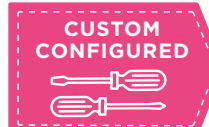

Silicone in basket and base can be customized to accommodate specific instrumentation. Silicone in image is for illustrative purposes only.

### THYROID SET | 25 INSTRUMENTS

## BEFORE

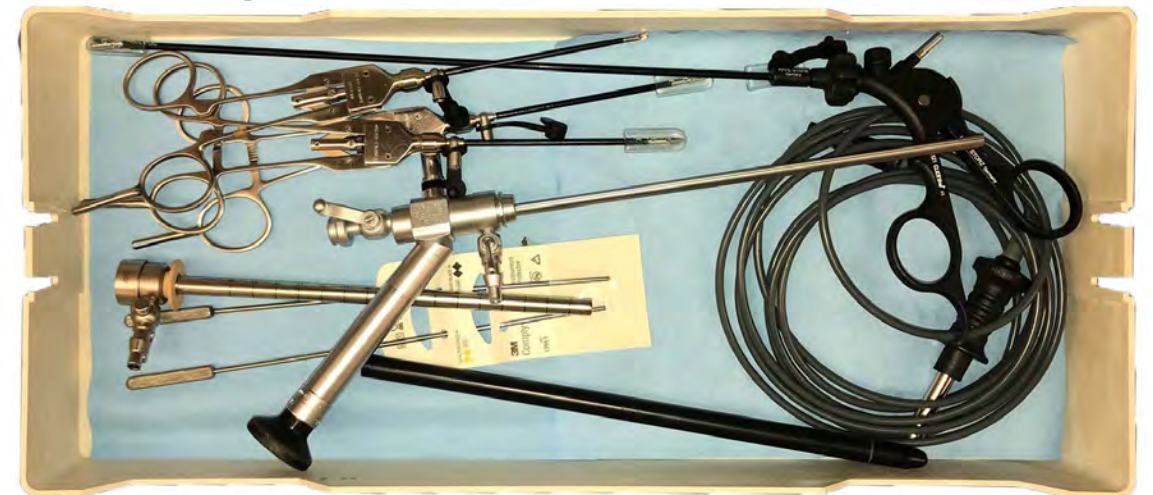

CUSTOM CONFIGURED

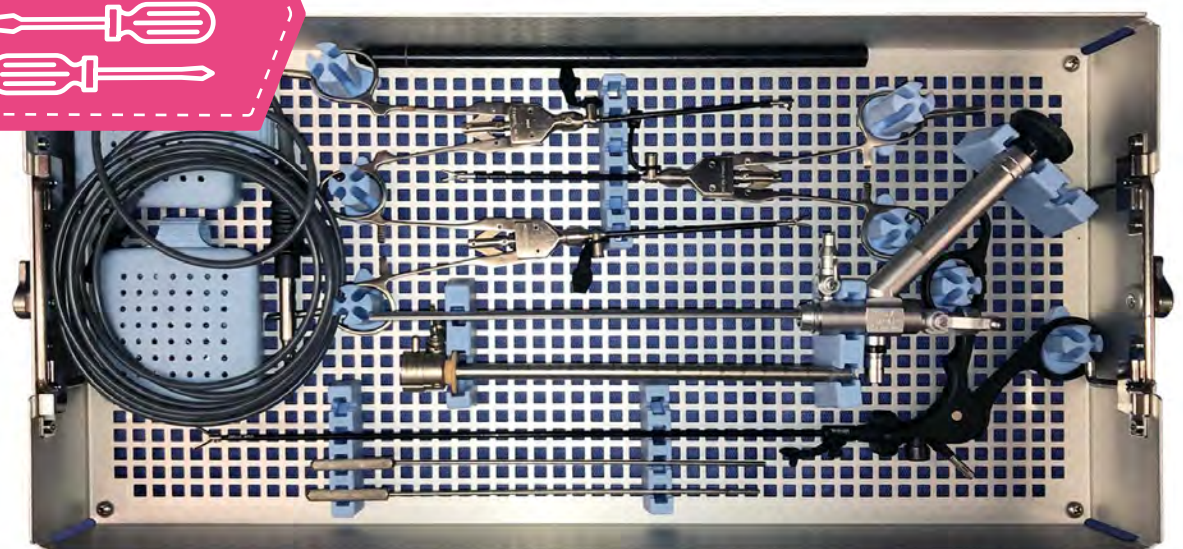
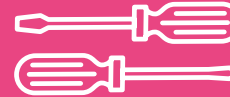

## AFTER

**CALL US TODAY FOR CUSTOMIZATION!**

Tray shown without cover for illustrative purposes. All custom InstruSafe Trays come with a cover to provide 360 degrees of protection.



## Preconfigured Tray for General

Our battery tray options are redesigned to fit various battery sizes seamlessly, ensuring secure organization and protection for surgical power instruments during reprocessing.



## Preconfigured Tray for General

Protection and organization of your laparoscopic instrument sets with this three-level tray constructed to fit both small and large sets of instrumentation.



UNIVERSAL BATTERY TRAY SINGLE	
Holds: • 1 Battery	
3 ¾ L x 3 ½ W x 3 ⅝ H (in)	95 L x 89 W x 92 H (mm)
Wrapped Foot IN-5017-R	

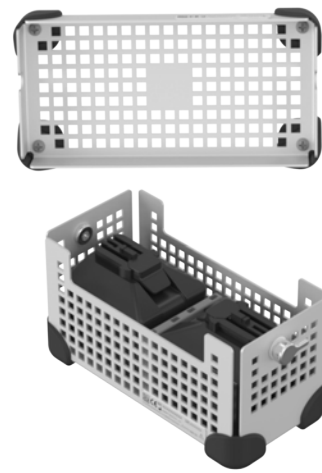

UNIVERSAL BATTERY TRAY DUAL	
Holds: • 2 Batteries	
7 ½ L x 3 ½ W x 3 ⅝ H (in)	191 L x 89 W x 92 H (mm)
Wrapped Foot IN-5015-R	



UNIVERSAL BATTERY TRAY THREE	
Holds: • 3 Batteries	
12 L x 3 ½ W x 3 ⅝ H (in)	305 L x 89 W x 92 H (mm)
Wrapped Foot IN-5016-R	

Cover

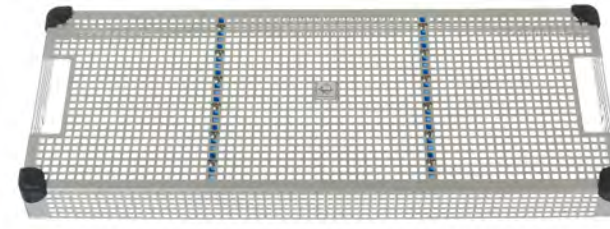

EXTRA LONG LAPAROSCOPIC TRAY	
Holds: A combination of up to 11 of the following instruments: <ul style="list-style-type: none"> <li>Laparoscopic Instruments</li> <li>General Dissecting Instruments</li> <li>Miscellaneous Parts</li> <li>Tubing/Cords</li> <li>Cannulas</li> <li>Sheaths</li> <li>Trocars</li> </ul>	
24 ¾ L x 9 ⅝ W x 6 H (in)	629 L x 244 W x 152 H (mm)
Wrapped Foot IN-8865-R	Container Foot IN-8865-TF

Shelf



Expand capacity with positionable Hold-Its™ and Hold-Downs™ silicone instrument holders.  
Multi-level to accommodate a high quantity of instruments.

Basket

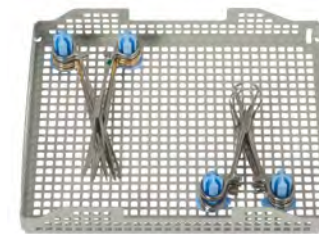

Silicone in basket and base can be customized to accommodate specific instrumentation. Silicone in image is for illustrative purposes only.

Base

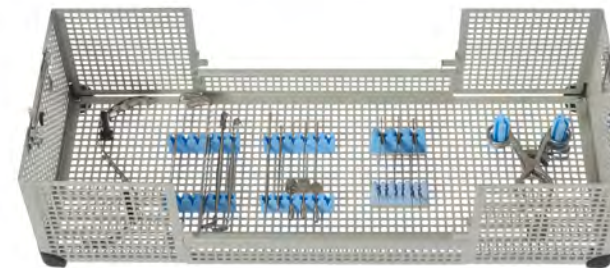

**CALL US TODAY FOR CUSTOMIZATION!**

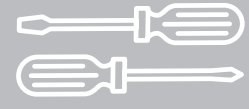

### Custom Configured Tray Example for General

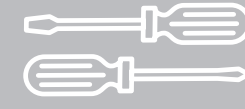

### Custom Configured Tray Example for General

#### TENDON STRIPPER | 13 INSTRUMENTS

## BEFORE



CUSTOM CONFIGURED

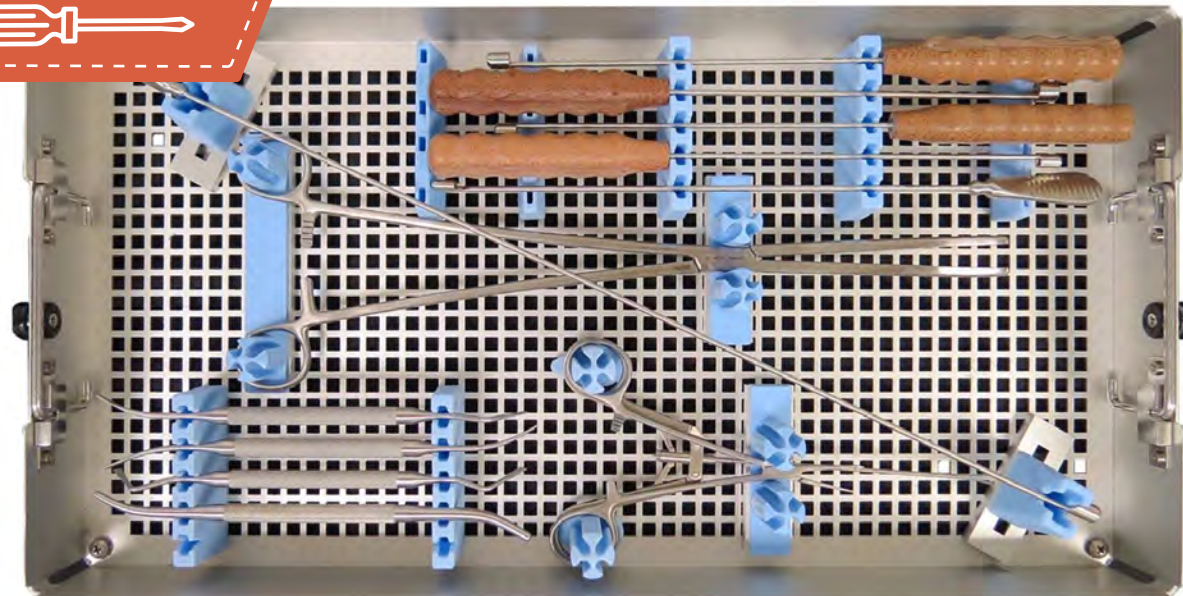

## AFTER

#### LAPAROSCOPIC | 47 INSTRUMENTS

CUSTOM CONFIGURED

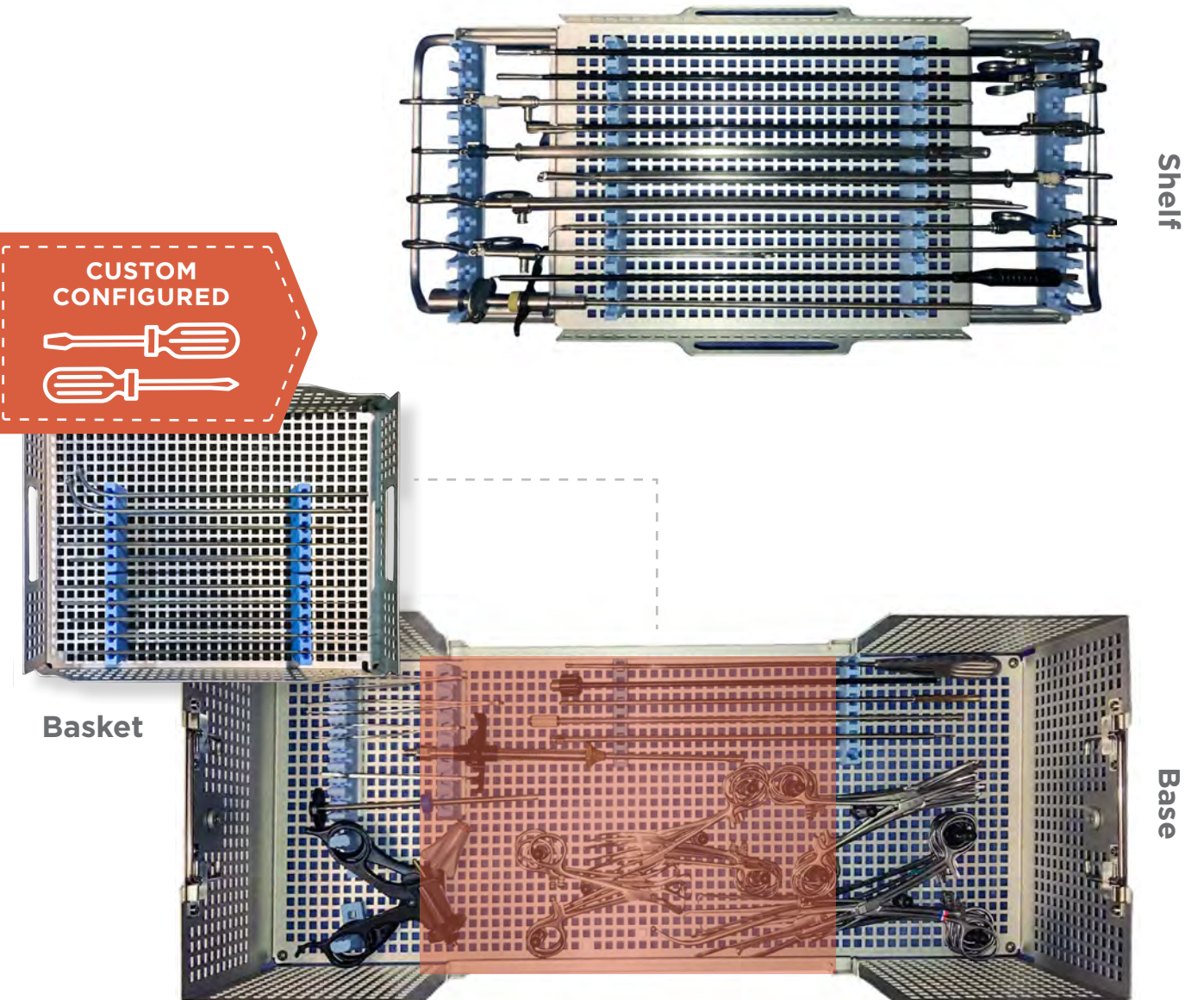

Tray shown without cover for illustrative purposes. All custom InstruSafe Trays come with a cover to provide 360 degrees of protection.

Tray shown without cover for illustrative purposes. All custom InstruSafe Trays come with a cover to provide 360 degrees of protection.

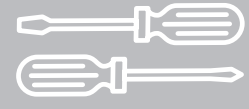

Custom Configured Tray Example for  
**Hysteroscopy**

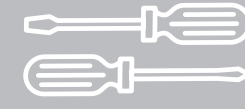

Custom Configured Tray Example for  
**Hysteroscopy**

HYSTEROSCOPE SET | 10 INSTRUMENTS

HYSTERECTOMY RESECTOSCOPE TRAY | 15 INSTRUMENTS

**BEFORE**

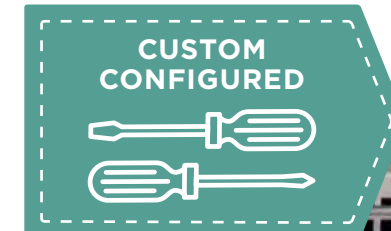
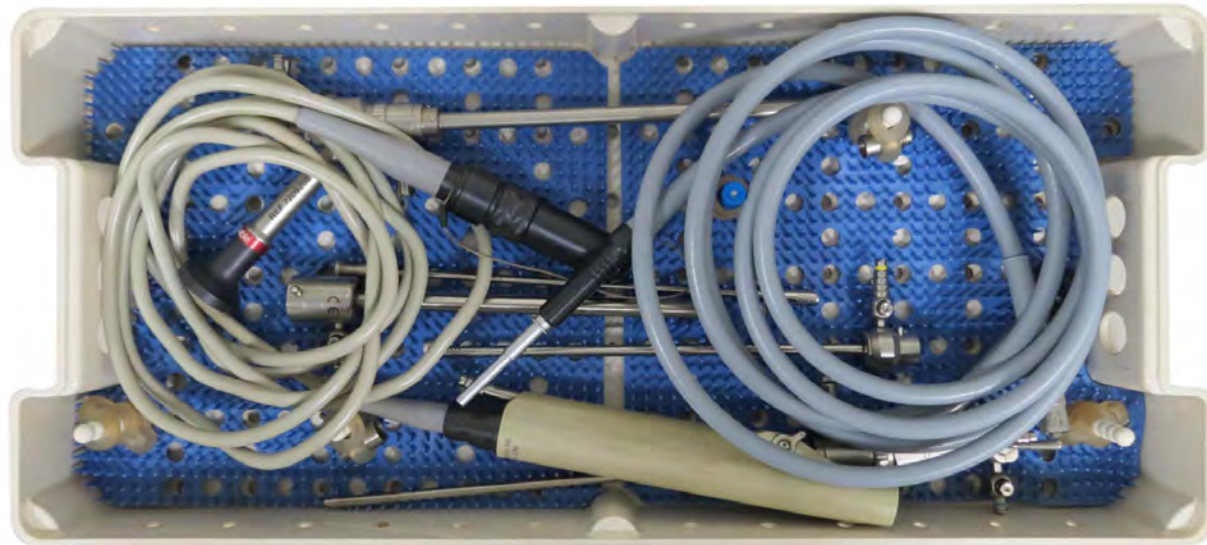

**CUSTOM CONFIGURED**

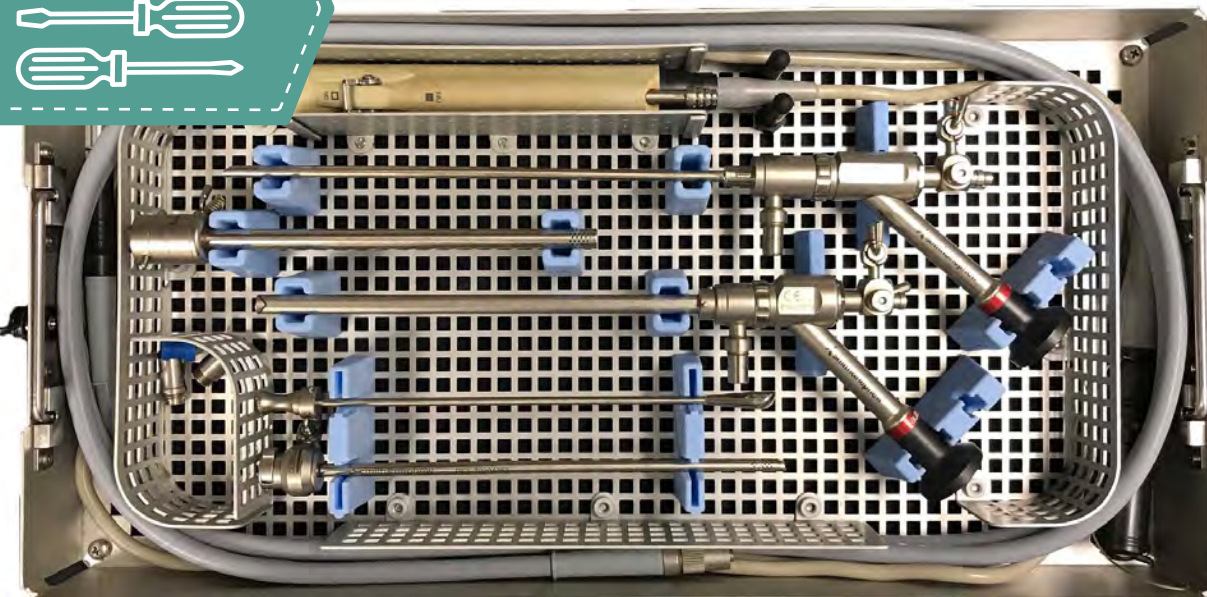

**AFTER**

Shelf

Base

Tray shown without cover for illustrative purposes. All custom InstruSafe Trays come with a cover to provide 360 degrees of protection.

Tray shown without cover for illustrative purposes. All custom InstruSafe Trays come with a cover to provide 360 degrees of protection.



## Preconfigured Trays for Kerrisons

Our Neurology and Spine Trays provide accessibility and flexibility when handling and sterilizing kerrisons.



## Preconfigured Trays for Bi-Polar Forceps

ARTHRO  
BARIATRIC  
CARDIO  
DENTAL  
ENT  
GENERAL  
GYN  
NEURO  
EYE  
ORTHO  
PLASTICS  
RETRACTORS  
SCOPES  
ROBOTICS  
ACCESSORIES  
TRANSPORT CONTAINERS

ARTHRO  
BARIATRIC  
CARDIO  
DENTAL  
ENT  
GENERAL  
GYN  
NEURO  
EYE  
ORTHO  
PLASTICS  
RETRACTORS  
SCOPES  
ROBOTICS  
ACCESSORIES  
TRANSPORT CONTAINERS



Tray shown without cover for illustrative purposes.

10 POSITION KERRISON TRAY + RACK	
Holds: • 10 Kerrisons	
15 ¼ L x 9 ⅝ W x 6 H (in)	387 L x 244 W x 152 H (mm)
Wrapped Foot IN-5012-R	Container Foot IN-5012-TF



BAYONET DUAL FORCEPS MODULE TRAY	
Holds: • 2 Forceps	
9 ¾ L x 2 ⅞ W x 1 ½ H (in)	248 L x 54 W x 29 H (mm)
IN-5401-02	

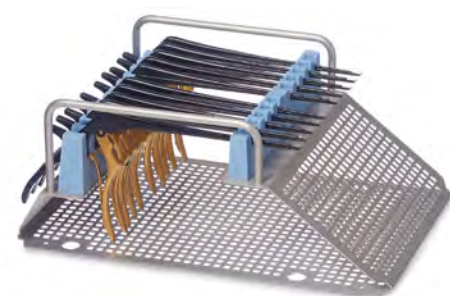

10 POSITION KERRISON RACK	
Holds: • 10 Kerrisons	
14 ¼ L x 9 ½ W x 6 H (in)	362 L x 241 W x 152 H (mm)
No Foot IN-5013-NF	Container Foot IN-5013-TF

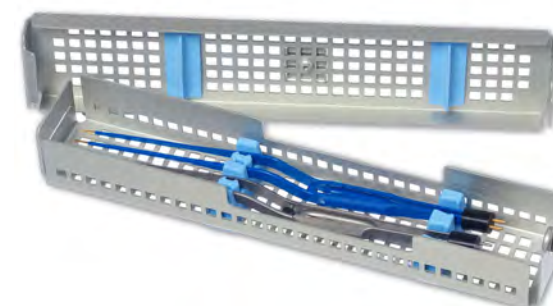

BAYONET DUAL X-LONG FORCEPS MODULE TRAY	
Holds: • 2 Forceps	
12 L x 2 ⅞ W x 1 ½ H (in)	305 L x 54 W x 38 H (mm)
IN-5401-03	

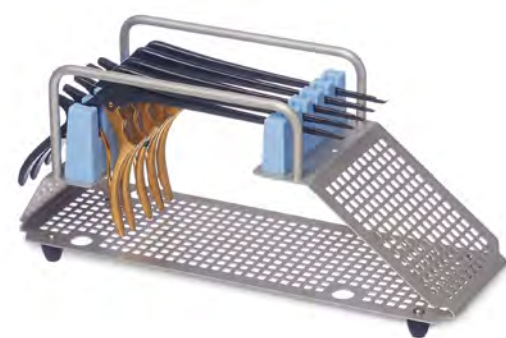

5 POSITION KERRISON RACK	
Holds: • 5 Kerrisons	
14 ¼ L x 5 W x 6 H (in)	362 L x 127 W x 152 H (mm)
No Foot IN-5014-NF	Container Foot IN-5014-TF



BAYONET SIX FORCEPS MODULE TRAY	
Holds: • 6 Forceps	
9 ¾ L x 4 ⅝ W x 1 ½ H (in)	248 L x 248 W x 29 H (mm)
IN-5401	

Preconfigured Trays for  
**Bi-Polar Forceps**



Custom Configured Tray Example for  
**Neurology/Spine**

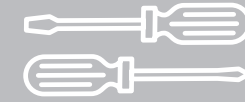

BAYONET EIGHT FORCEPS MODULE TRAY	
Holds: • 8 Forceps	
12 L x 7 ¼ W x 1 ½ H (in)	305 L x 184 W x 38 H (mm)
IN-5401-08	



BAYONET TWELVE FORCEPS MODULE TRAY	
Holds: • 12 Forceps	
12 L x 9 ¾ W x 1 ½ H (in)	305 L x 244 W x 38 H (mm)
IN-5401-12	

NEUROLOGY TRAY | 13 INSTRUMENTS

**BEFORE**

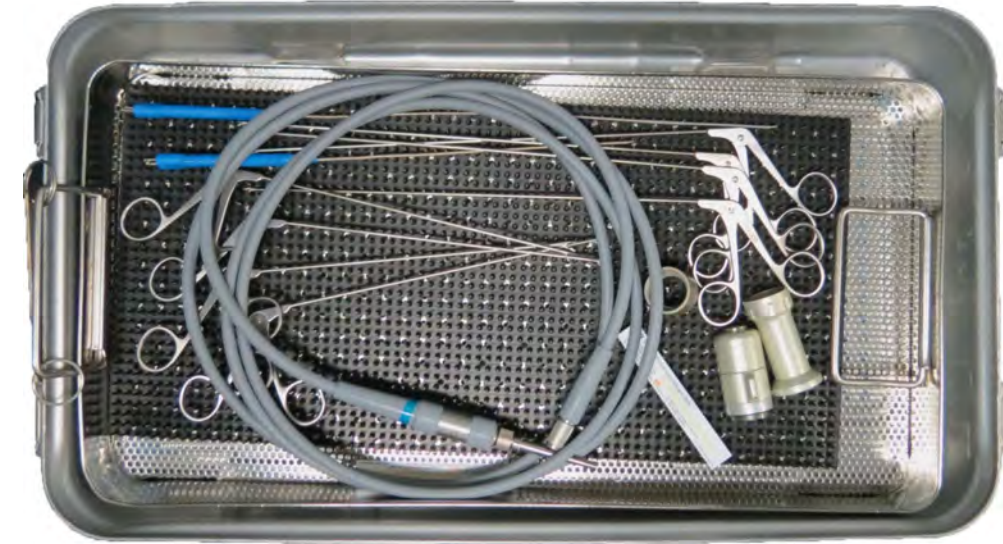

CUSTOM CONFIGURED

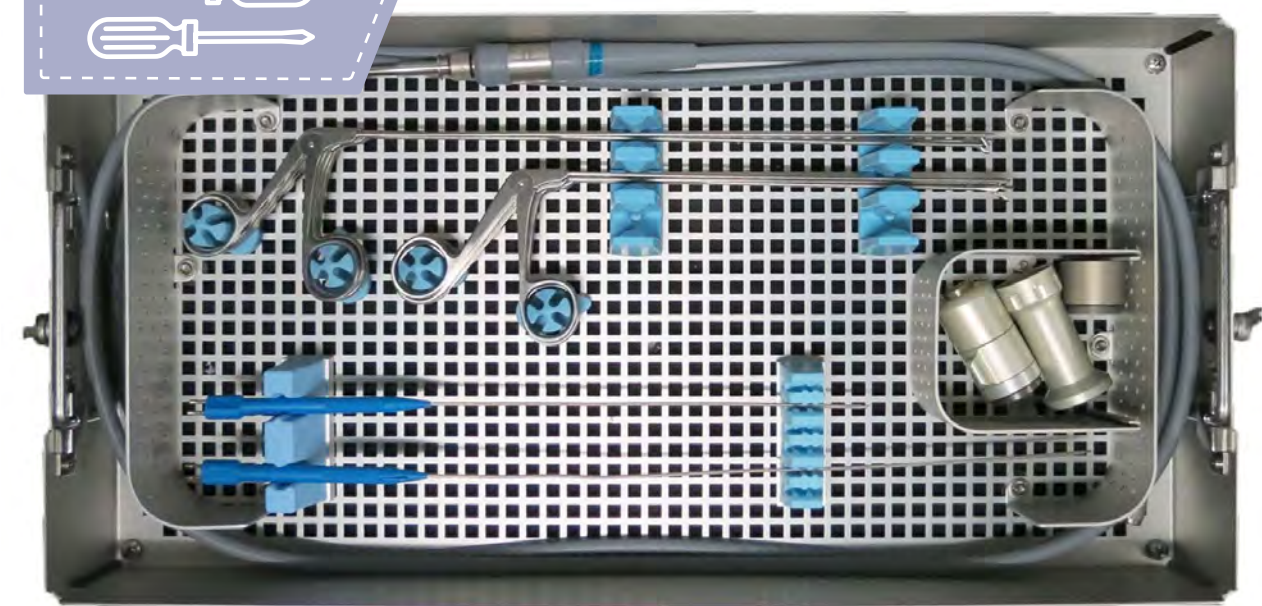
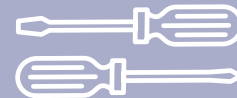

**AFTER**

Tray shown without cover for illustrative purposes. All custom InstruSafe Trays come with a cover to provide 360 degrees of protection.

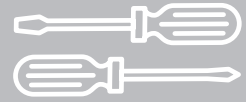

### Custom Configured Tray Example for Neurology/Spine

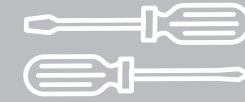

### Custom Configured Tray Example for Neurology/Spine

HIGH SPEED PNEUMATIC DRILL TRAY | 9 INSTRUMENTS

DURAL REPAIR KIT TRAY | 18 INSTRUMENTS

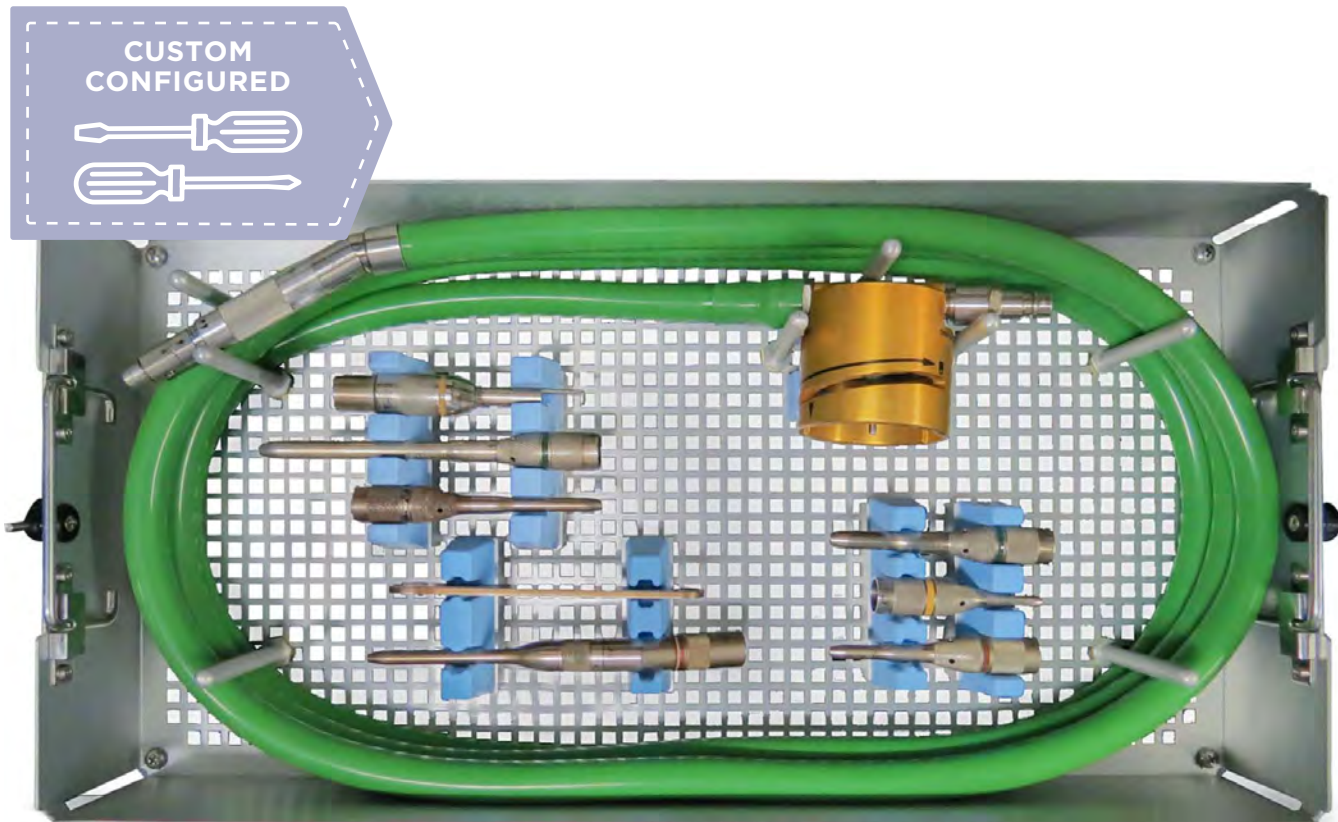

CUSTOM CONFIGURED

CUSTOM CONFIGURED

Tray shown without cover for illustrative purposes. All custom InstruSafe Trays come with a cover to provide 360 degrees of protection.

Tray shown without cover for illustrative purposes. All custom InstruSafe Trays come with a cover to provide 360 degrees of protection.

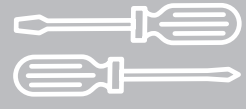

### Custom Configured Tray Example for Ophthalmology

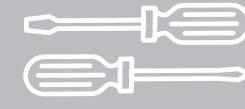

### Custom Configured Tray Example for Ophthalmology

#### CATARACT-PHACO SET | 28 INSTRUMENTS

#### EYE TRAY | 57 INSTRUMENTS

**BEFORE**

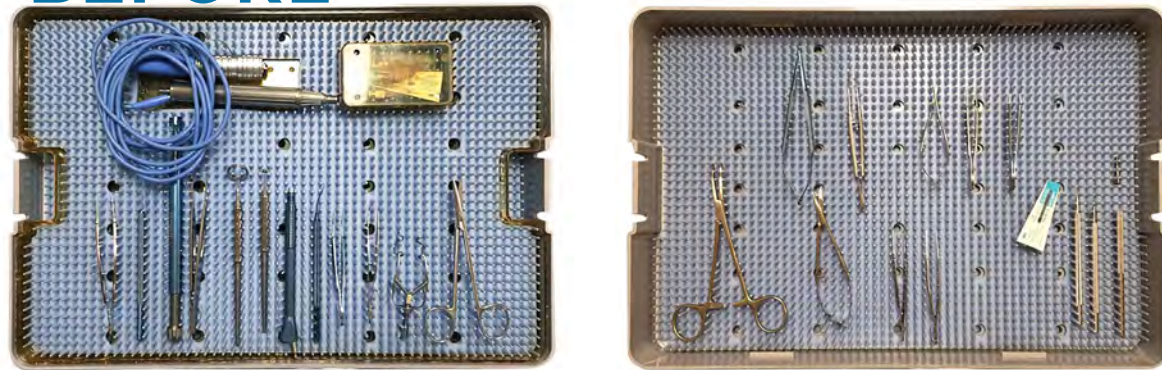

**CUSTOM CONFIGURED**

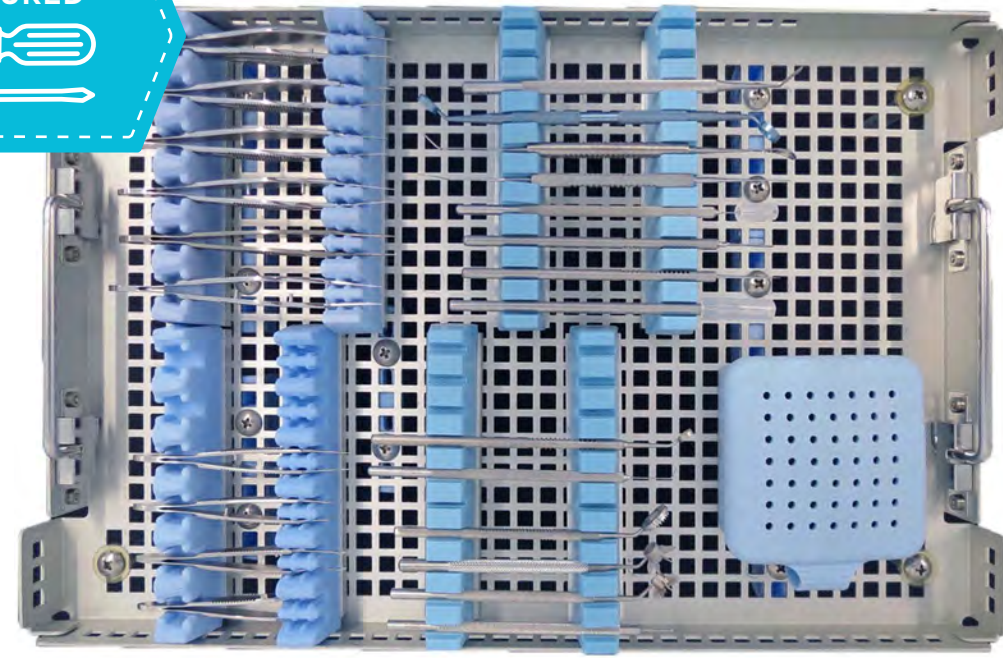
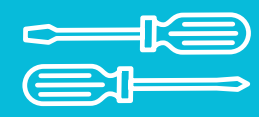

Shelf

**CUSTOM CONFIGURED**

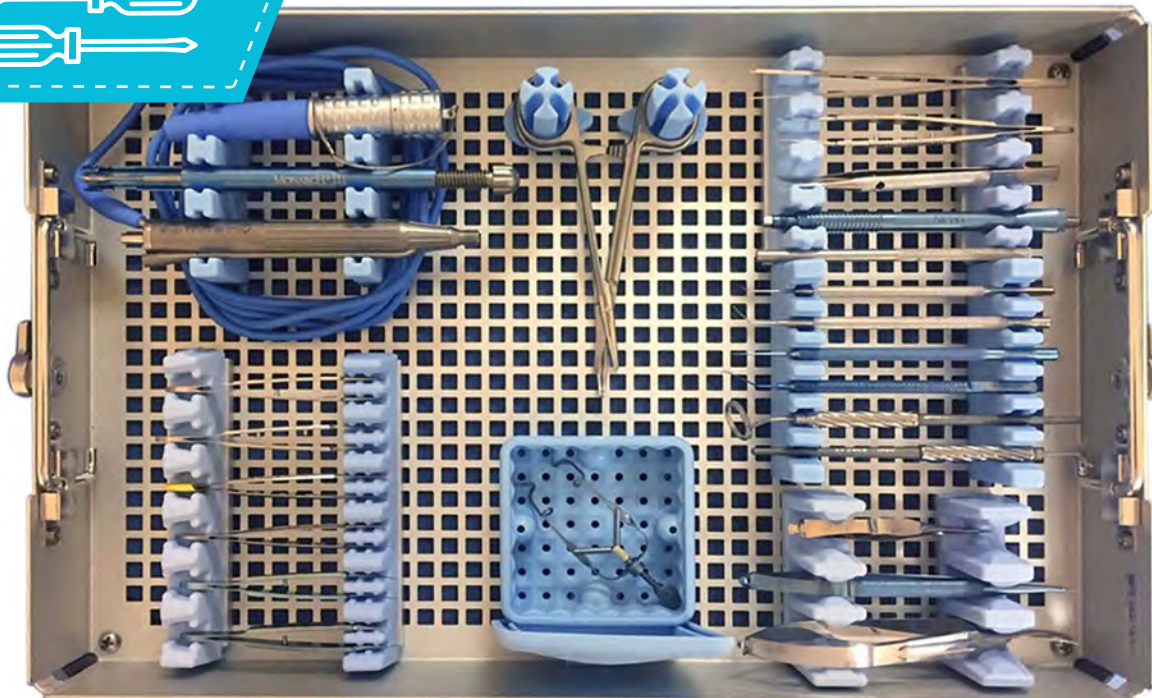
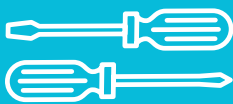

**AFTER**

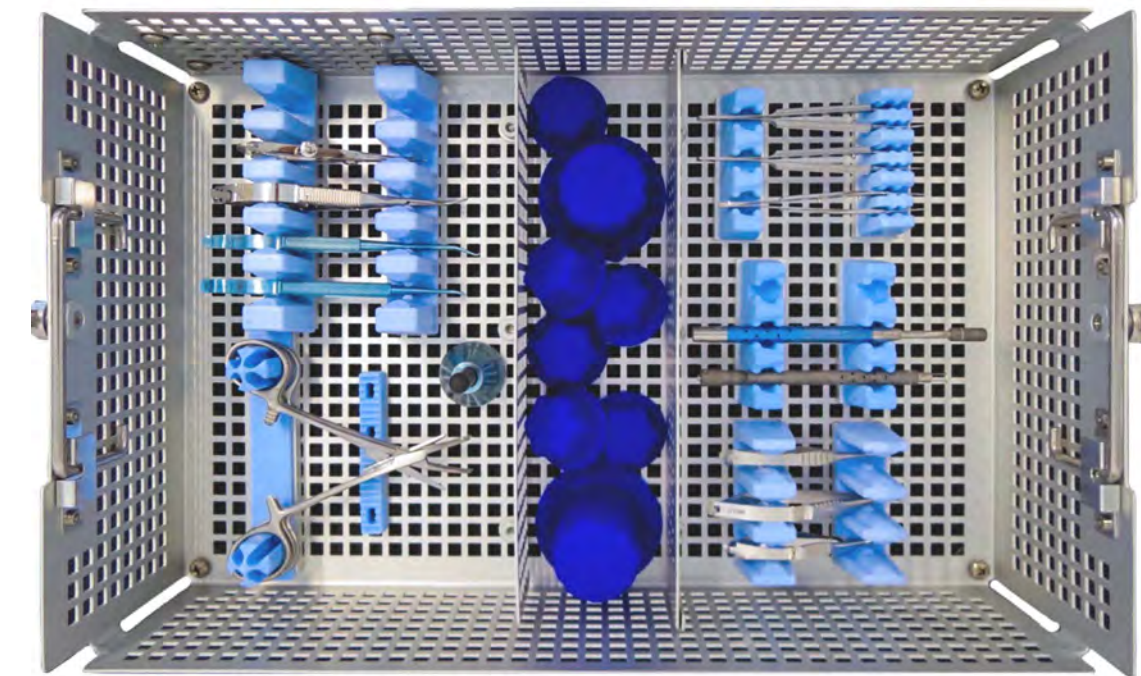

Base

Tray shown without cover for illustrative purposes. All custom InstruSafe Trays come with a cover to provide 360 degrees of protection.

Tray shown without cover for illustrative purposes. All custom InstruSafe Trays come with a cover to provide 360 degrees of protection.

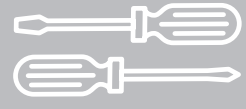

### Custom Configured Tray Example for Ophthalmology

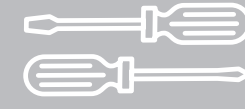

### Custom Configured Tray Example for Ophthalmology

CORNEA TRAY | 61 INSTRUMENTS

PHACO HAND PIECE TRAY | 23 INSTRUMENTS

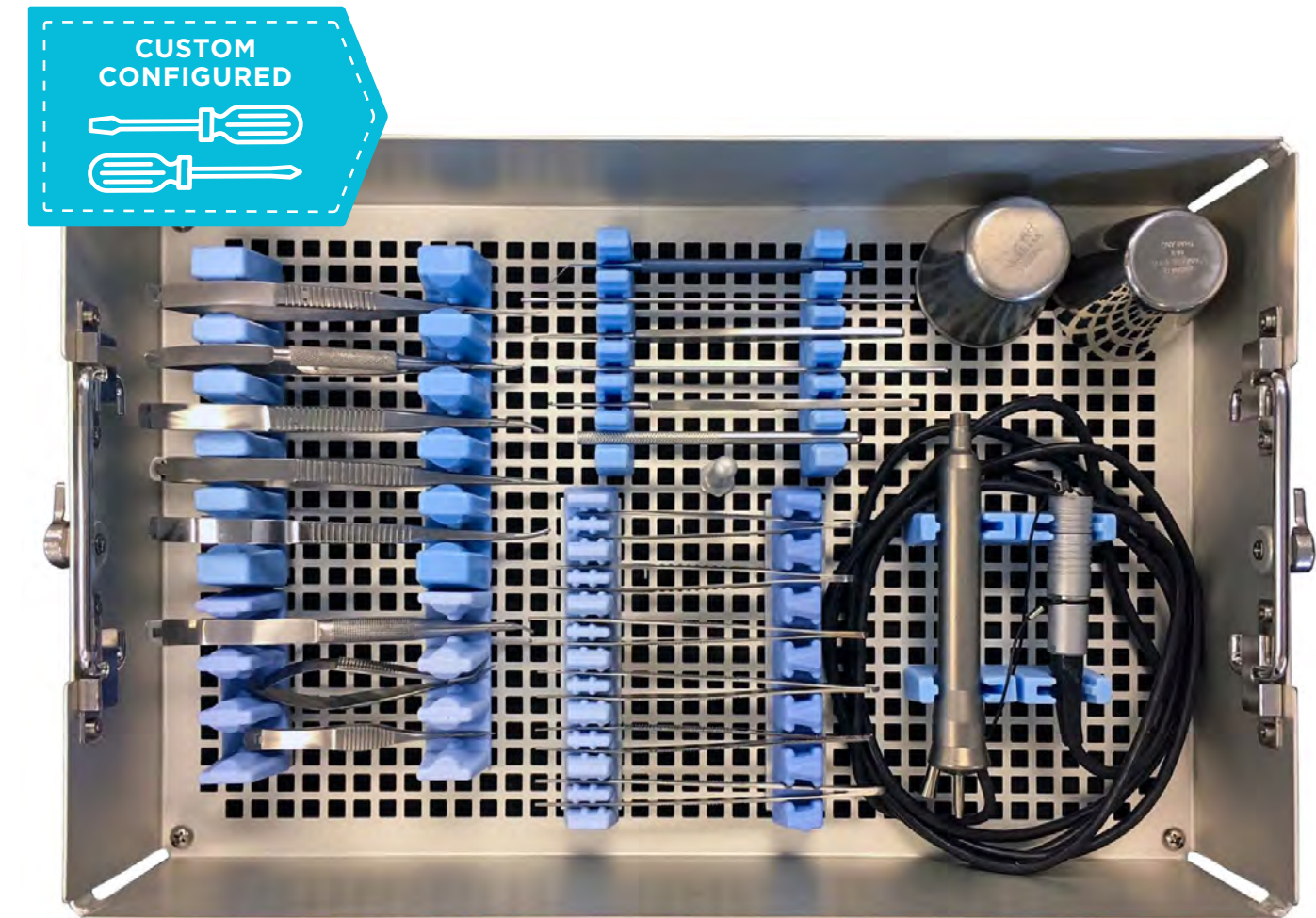
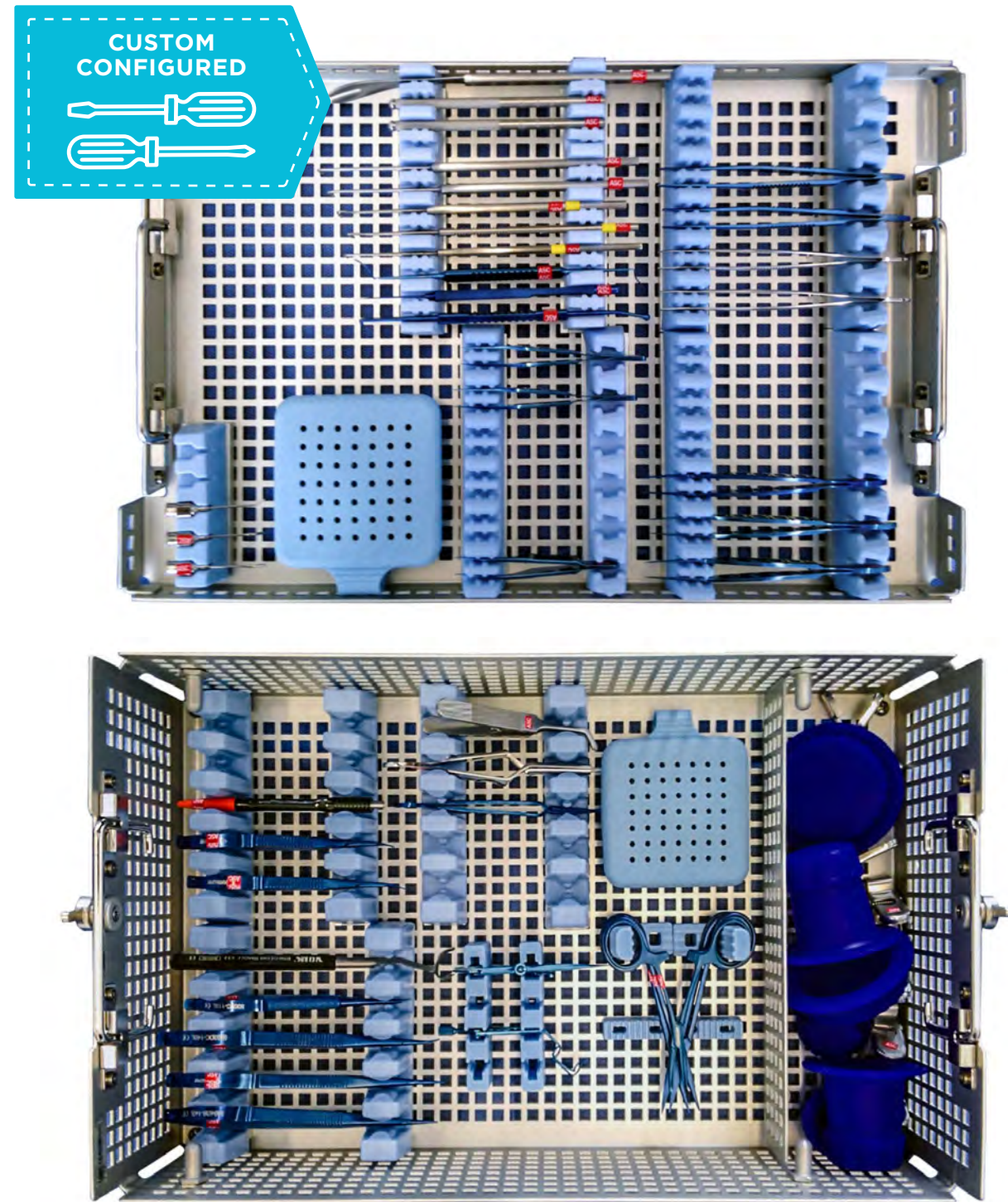

Tray shown without cover for illustrative purposes. All custom InstruSafe Trays come with a cover to provide 360 degrees of protection.

Tray shown without cover for illustrative purposes. All custom InstruSafe Trays come with a cover to provide 360 degrees of protection.

## Preconfigured Trays for Orthopedic

While not usually delicate, orthopedic instrumentation needs to be kept sharp and straight to get the job done. Our Ortho Trays are built to safely accommodate and protect instruments that are commonly found in almost all surgical facilities.

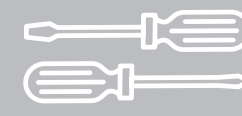

## Custom Configured Tray Example for Orthopedic

### SMALL FRAG SET | 23 INSTRUMENTS

**BEFORE**



**CUSTOM CONFIGURED**

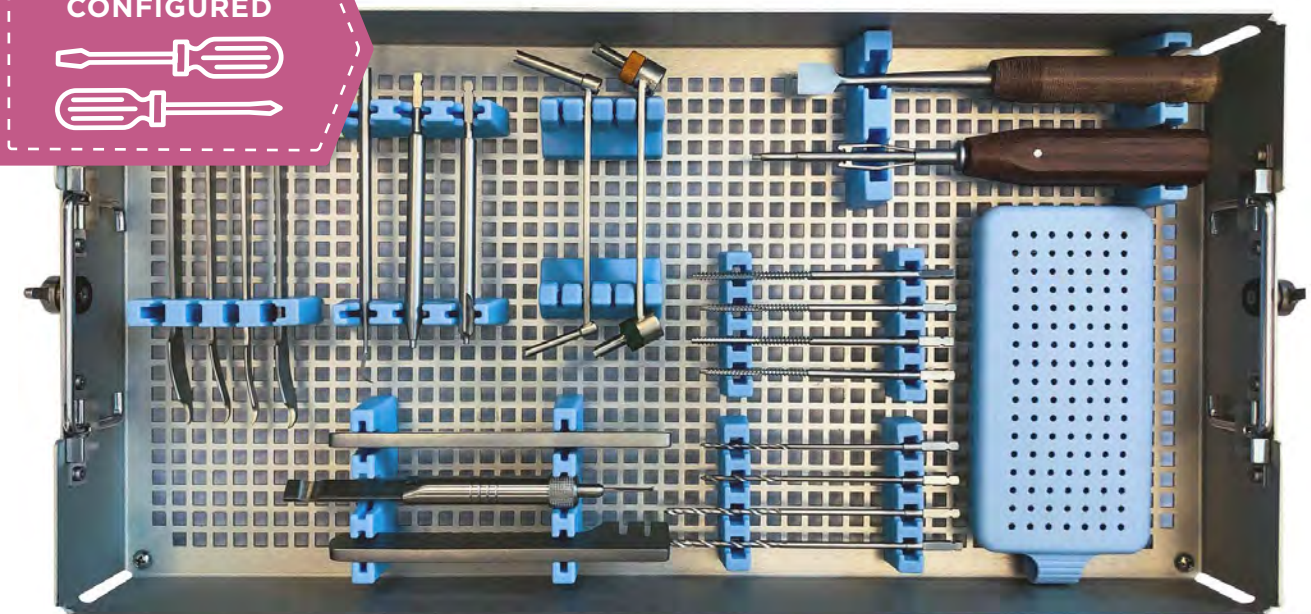
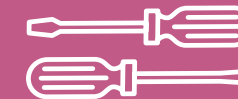

**AFTER**

Tray shown without cover for illustrative purposes. All custom InstruSafe Trays come with a cover to provide 360 degrees of protection.



LAMBOTTE OSTEOTOME TRAY	
Holds: • 12 Instruments—straight or curved, up to 1 1/2" width (38mm)	
8 3/8 L x 9 5/8 W x 3 H (in)	213 L x 244 W x 76 H (mm)
Wrapped Foot IN-5010-R	Container Foot IN-5010-TF



CURETTE TRAY	
Holds: • 14 Instruments—7-13" in length	
15 1/4 L x 9 5/8 W x 2 H (in)	387 L x 244 W x 51 H (mm)
Wrapped Foot IN-5011-R	Container Foot IN-5011-TF



KNEE POSITIONER TRAY	
Holds: • Surgical Knee positioning leg holder for knee replacement surgeries. • 30" Length Base with Carriage, Clamp and Boot	
31 3/8 L x 3 3/8 W x 6 H (in)	810 L x 270 W x 102 H (mm)
Wrapped Foot IN-5020-R	

ARTHRO

BARIATRIC

CARDIO

DENTAL

ENT

GENERAL

GYN

NEURO

EYE

ORTHO

PLASTICS

RETRACTORS

SCOPES

ROBOTICS

ACCESSORIES

TRANSPORT CONTAINERS

ARTHRO

BARIATRIC

CARDIO

DENTAL

ENT

GENERAL

GYN

NEURO

EYE

ORTHO

PLASTICS

RETRACTORS

SCOPES

ROBOTICS

ACCESSORIES

TRANSPORT CONTAINERS

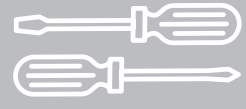

### Custom Configured Tray Example for Plastics

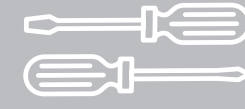

### Custom Configured Tray Example for Plastics

MICRO SET | 32 INSTRUMENTS

PLASTIC TRAY | 38 INSTRUMENTS

## BEFORE

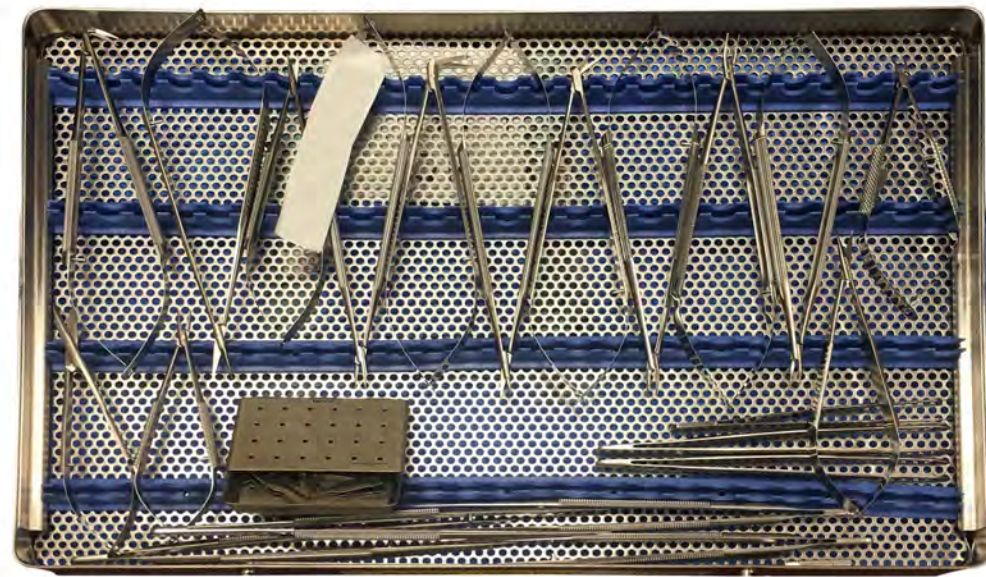

CUSTOM  
CONFIGURED

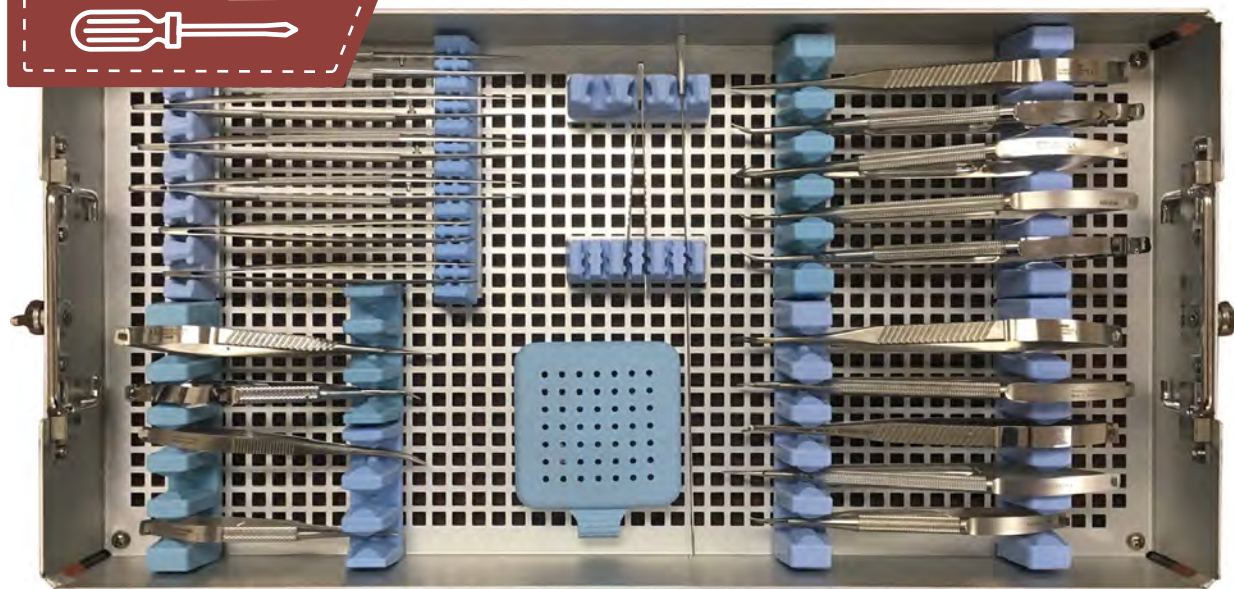
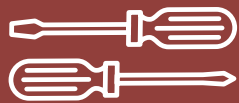

## AFTER

CUSTOM  
CONFIGURED

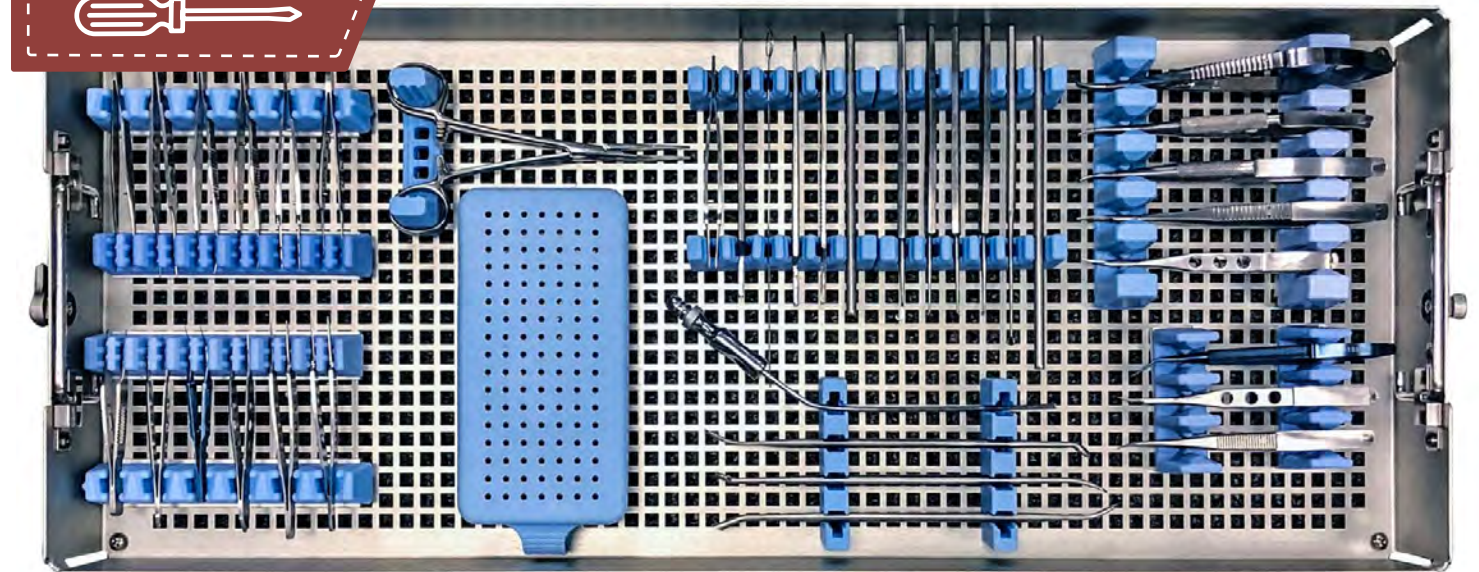
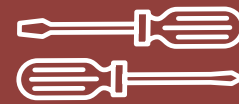

Tray shown without cover for illustrative purposes. All custom InstruSafe Trays come with a cover to provide 360 degrees of protection.

Tray shown without cover for illustrative purposes. All custom InstruSafe Trays come with a cover to provide 360 degrees of protection.

## Preconfigured Trays for Bookwalter® Retractors

This tray system is engineered to support balanced weight distribution & to help healthcare facilities maintain the AAMI ST79-recommended 25-lb maximum assembled set weight. We offer a two-level tray design made to accommodate the ring and blade components with an additional tray to store the table post and horizontal bar. Our two-tray system is organized for easy counting and safe for transporting.

**Note:** The Mediflex Bookler Retractor also fits in this tray.

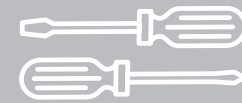

## Custom Configured Tray Example for Retractors

ARTHRO  
BARIATRIC  
CARDIO  
DENTAL  
ENT  
GENERAL  
GYN  
NEURO  
EYE  
ORTHO  
PLASTICS  
RETRACTORS  
SCOPES  
ROBOTICS  
ACCESSORIES  
TRANSPORT CONTAINERS

ARTHRO  
BARIATRIC  
CARDIO  
DENTAL  
ENT  
GENERAL  
GYN  
NEURO  
EYE  
ORTHO  
PLASTICS  
RETRACTORS  
SCOPES  
ROBOTICS  
ACCESSORIES  
TRANSPORT CONTAINERS



RING + BLADE TRAY	
Holds: • 1 (1") Post Coupling • 1 Balfour Retractor • 1 Horizontal Flex Bar • 1 Harrington Retractor • 1 Medium Oval Ring • 1 Segmented Ring • 1 Gelpi Retractor • 2 (2x6"/51mm x 152mm) Malleable Retractors • 1 (3x6"/76mm x 152mm) Malleable Retractor • 2 (2x3"/51mm x 76mm) Kelly Retractors • 1 (2x4"/51mm x 110mm) Kelly Retractor • 1 (2x5"/51mm x 127mm) Kelly Retractor • 1 (2x6"/51mm x 152mm) Kelly Retractor • 6 Tilt Ratchet Mechanisms • 2 Ratchet Mechanisms	
22 ½ L x 13 W x 4 ½ H (in)	572 L x 330 W x 114 H (mm)
Wrapped Foot IN-8700-R	Container Foot IN-8700-TF

### BOOKWALTER RETRACTOR TRAY | 38 INSTRUMENTS

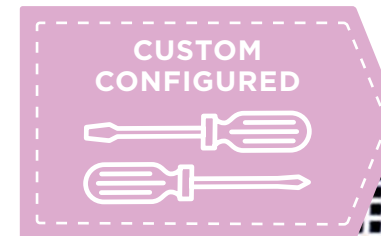

POST TRAY	
Holds: • Table Post and Horizontal Bar	
25 L x 5 ¾ W x 3 H (in)	635 L x 137 W x 76 H (mm)
Wrapped Foot IN-8701-R	Container Foot IN-8701-TF

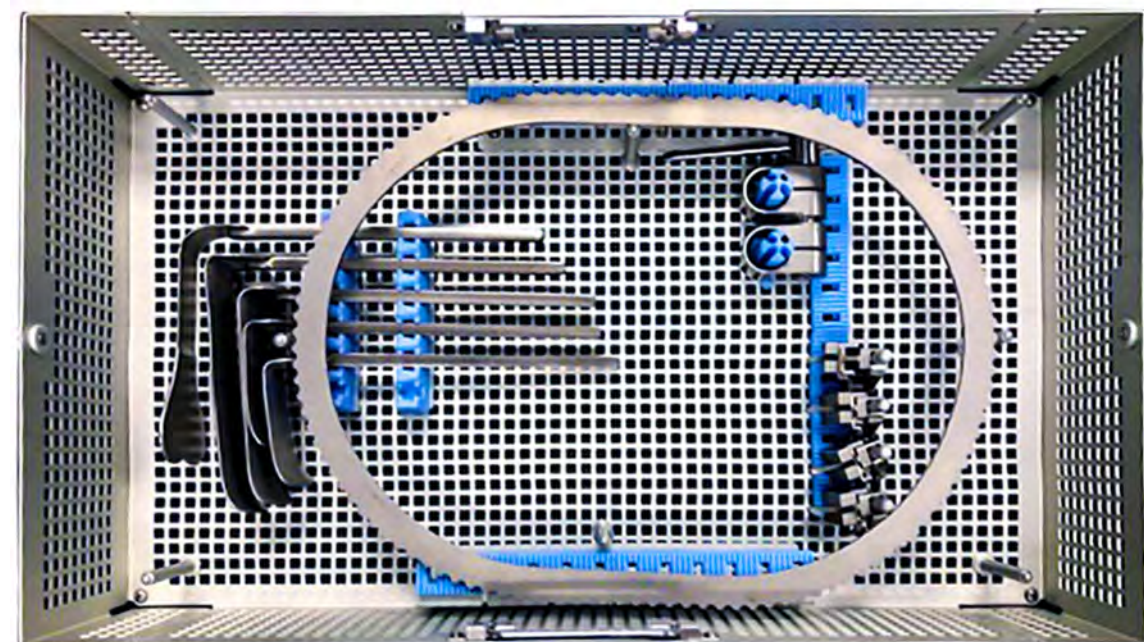

Tray shown without cover for illustrative purposes. All custom InstruSafe Trays come with a cover to provide 360 degrees of protection.

The Bookwalter trademark is a registered trademark of Symmetry Surgical, Inc., or its affiliates in the United States and other countries around the world. Original Bookwalter retractors are sold exclusively by Symmetry Surgical, Inc. The Mediflex Bookler Retractor is registered trademark of Mediflex.

The Bookwalter trademark is a registered trademark of Symmetry Surgical, Inc., or its affiliates in the United States and other countries around the world. Original Bookwalter retractors are sold exclusively by Symmetry Surgical, Inc. The Mediflex Bookler Retractor is registered trademark of Mediflex.

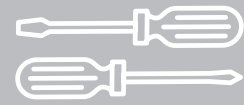

### Custom Configured Tray Example for Retractors

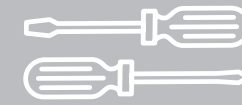

### Custom Configured Tray Example for Retractors

GREENBERG SET | 17 INSTRUMENTS

CARDIAC MIS RETRACTOR HOLDER TRAY | 2 INSTRUMENTS

**BEFORE**

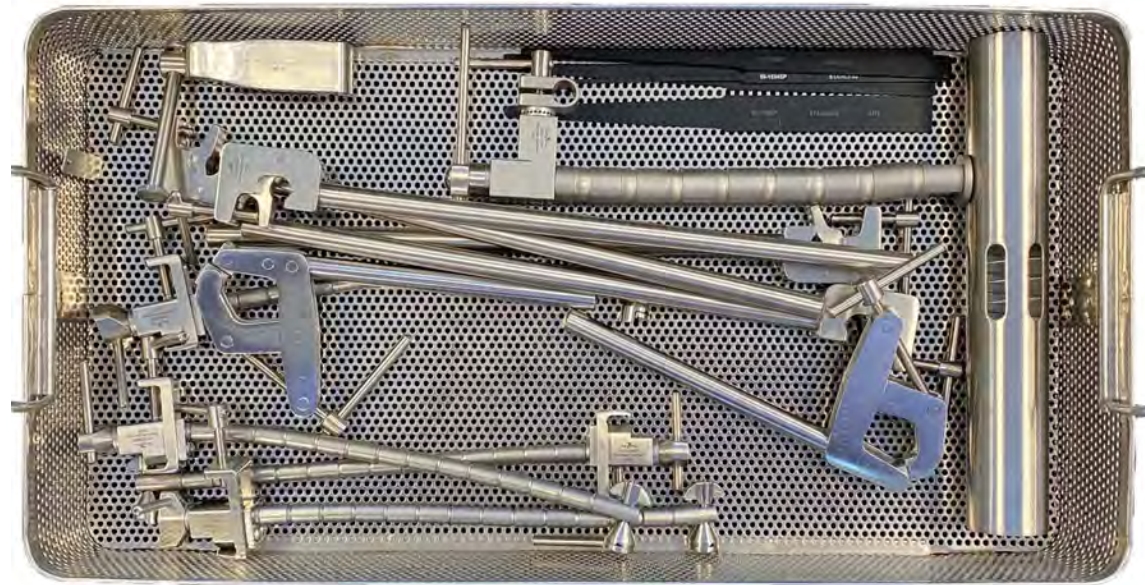

**CUSTOM CONFIGURED**

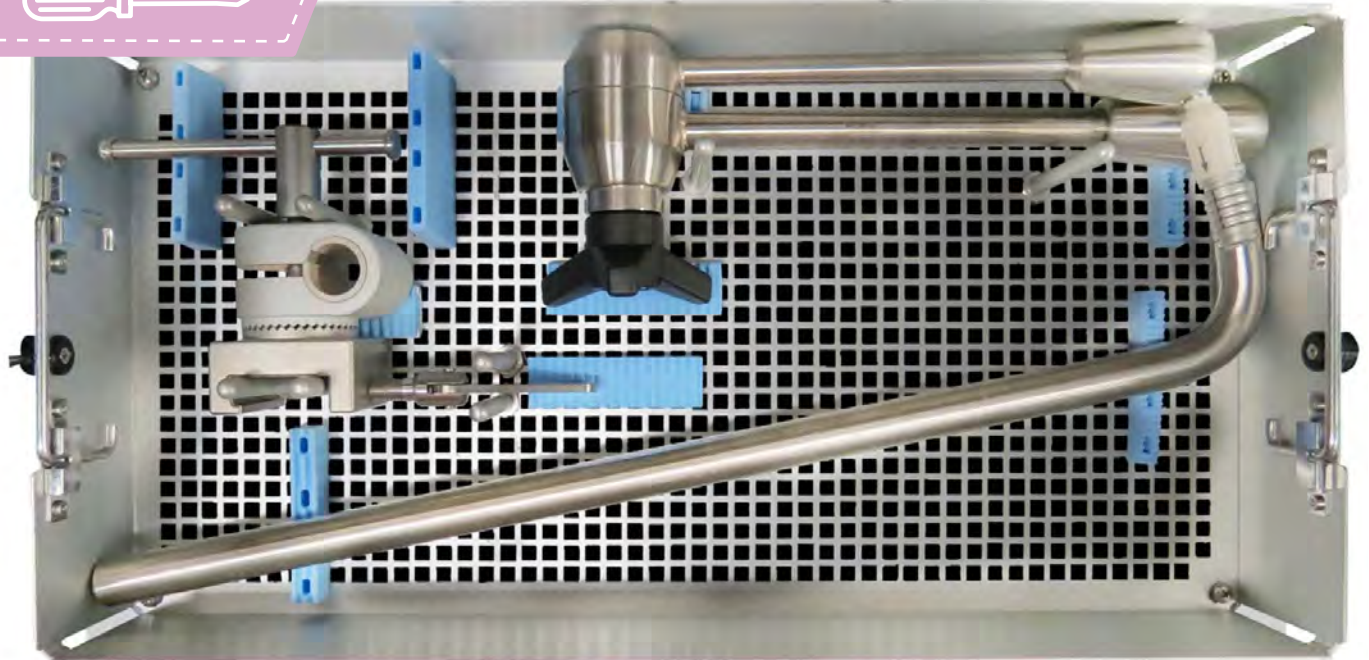
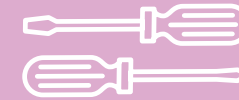

**CUSTOM CONFIGURED**

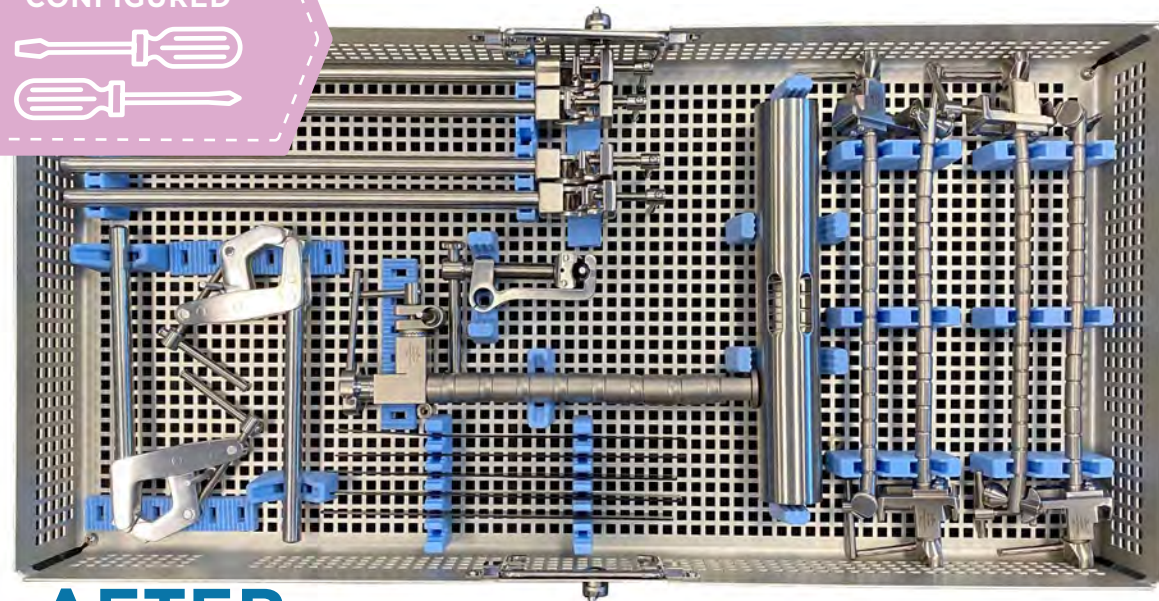
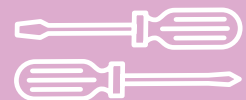

**AFTER**

Tray shown without cover for illustrative purposes. All custom InstruSafe Trays come with a cover to provide 360 degrees of protection.

Tray shown without cover for illustrative purposes. All custom InstruSafe Trays come with a cover to provide 360 degrees of protection.



## Preconfigured Trays for Rigid Scopes

Our rigid scope trays are designed to fit scopes of various sizes for any procedure.



## Preconfigured Trays for Rigid Scopes

ARTHRO  
BARIATRIC  
CARDIO  
DENTAL  
ENT  
GENERAL  
GYN  
NEURO  
EYE  
ORTHO  
PLASTICS  
RETRACTORS  
SCOPES  
ROBOTICS  
ACCESSORIES  
TRANSPORT CONTAINERS

ARTHRO  
BARIATRIC  
CARDIO  
DENTAL  
ENT  
GENERAL  
GYN  
NEURO  
EYE  
ORTHO  
PLASTICS  
RETRACTORS  
SCOPES  
ROBOTICS  
ACCESSORIES  
TRANSPORT CONTAINERS

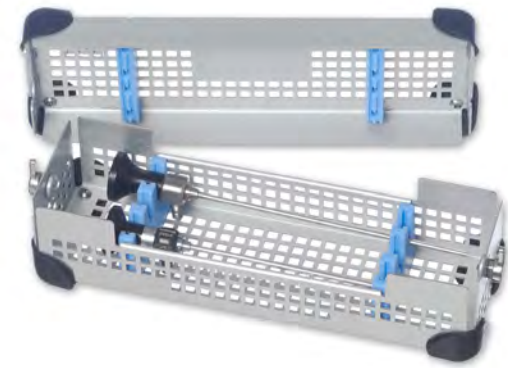

RIGID SCOPE TRAY - 4-7"	
Holds: • Up to 3 (2-10mm) Scopes • Accommodates scopes from 4-7" in working length	
11 L x 3 ¼ W x 2 ¾ H (in)	279 L x 83 W x 60 H (mm)
Wrapped Foot IN-6011-R	



RIGID SCOPE TRAY - 9½-21½"	
Holds: • Up to 3 (2-10mm) Scopes • Accommodates scopes from 9½-21½" in working length	
25 ¼ L x 3 ¼ W x 2 ¾ H (in)	641 L x 83 W x 60 H (mm)
Wrapped Foot IN-6014-R	



RIGID SCOPE TRAY - 5-13½"	
Holds: • Up to 3 (2-10mm) Scopes • Accommodates scopes from 5-13½" in working length	
17 ½ L x 3 ¼ W x 2 ¾ H (in)	445 L x 83 W x 60 H (mm)
Wrapped Foot IN-6012-R	



RIGID SCOPE TRAY - 11-26"	
Holds: • Up to 3 (2-10mm) Scopes • Accommodates scopes from 11-26" in working length	
30 ¼ L x 3 ¼ W x 2 ¾ H (in)	765 L x 83 W x 60 H (mm)
Wrapped Foot IN-6015-R	



RIGID SCOPE TRAY - 7-16½"	
Holds: • Up to 3 (2-10mm) Scopes • Accommodates scopes from 7-16½" in working length	
20 ¼ L x 3 ¼ W x 2 ¾ H (in)	515 L x 83 W x 60 H (mm)
Wrapped Foot IN-6013-R	



## Preconfigured Trays for Scope + Cable

Our scope + cable trays protect delicate fiber optics within the scope.

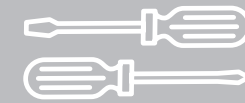

## Custom Configured Tray Example for Scope + Cable

ARTHRO

BARIATRIC

CARDIO

DENTAL

ENT

GENERAL

GYN

NEURO

EYE

ORTHO

PLASTICS

RETRACTORS

SCOPES

ROBOTICS

ACCESSORIES

TRANSPORT CONTAINERS



RIGID SCOPE + CABLE TRAY - 5-6"	
Holds:	
<ul style="list-style-type: none"> <li>Up to 3 (2-10mm) Scopes</li> <li>1 Cable</li> <li>Accommodates scopes from 5-6" in working length</li> </ul>	
11 L x 6 3/8 W x 2 3/8 H (in)	279 L x 162 W x 60 H (mm)
Wrapped Foot IN-6031-R	



RIGID SCOPE + CABLE TRAY - 5-13 1/2"	
Holds:	
<ul style="list-style-type: none"> <li>Up to 3 (2-10mm) Scopes</li> <li>1 Cable</li> <li>Accommodates scopes from 5-13 1/2" in working length</li> </ul>	
20 1/2 L x 5 5/8 W x 2 3/8 H (in)	521 L x 143 W x 60 H (mm)
Wrapped Foot IN-6032-R	



RIGID SCOPE + CABLE TRAY - 6 1/2-17"	
Holds:	
<ul style="list-style-type: none"> <li>Up to 3 (2-10mm) Scopes</li> <li>1 Cable</li> <li>Accommodates scopes from 6 1/2-17" in working length</li> </ul>	
25 L x 5 3/8 W x 2 3/8 H (in)	635 L x 137 W x 60 H (mm)
Wrapped Foot IN-6033-R	

### RESECTOSCOPE | 11 INSTRUMENTS

## BEFORE



### CUSTOM CONFIGURED

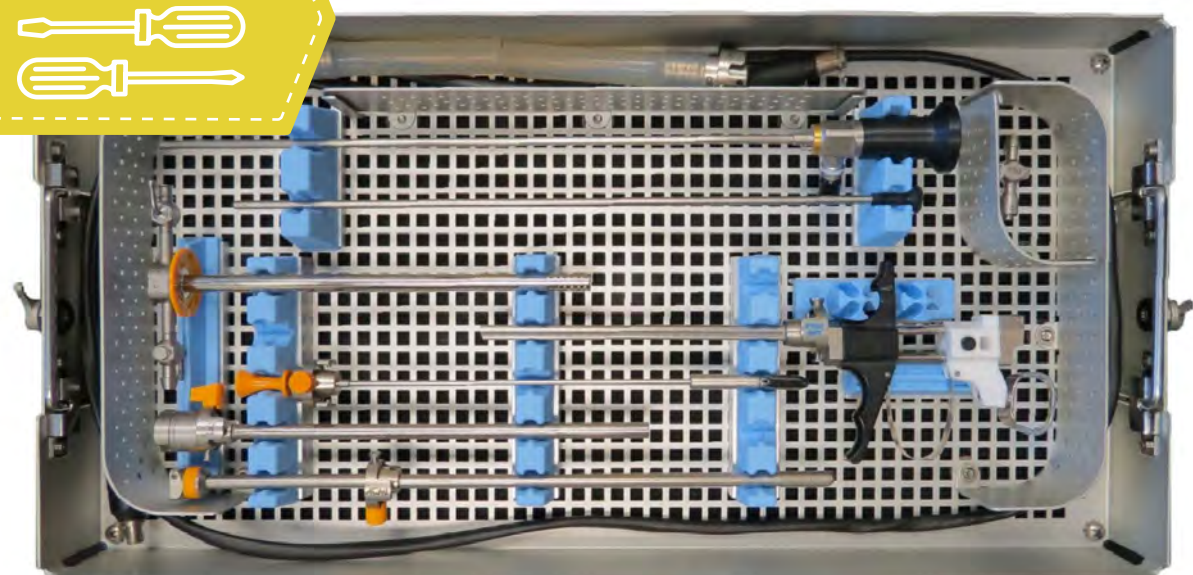
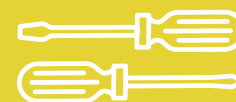

## AFTER

Tray shown without cover for illustrative purposes. All custom InstruSafe Trays come with a cover to provide 360 degrees of protection.



## Preconfigured Trays for Flexible Scopes

Our flexible scope trays are sure to protect your delicate and expensive scopes. Our Small Parts Boxes are perfect to keep all your accessories together and protected.



## Preconfigured Tray for Flexible Scopes

ARTHRO  
BARIATRIC  
CARDIO  
DENTAL  
ENT  
GENERAL  
GYN  
NEURO  
EYE  
ORTHO  
PLASTICS  
RETRACTORS  
SCOPES  
ROBOTICS  
ACCESSORIES  
TRANSPORT CONTAINERS

ARTHRO  
BARIATRIC  
CARDIO  
DENTAL  
ENT  
GENERAL  
GYN  
NEURO  
EYE  
ORTHO  
PLASTICS  
RETRACTORS  
SCOPES  
ROBOTICS  
ACCESSORIES  
TRANSPORT CONTAINERS



FLEXIBLE SCOPE TRAY	
Holds: • 1 Flexible Scope • Accommodates scopes from 12-27" in working length	
19 5/8 L x 9 5/8 W x 3 H (in)	498 L x 244 W x 76 H (mm)
Wrapped Foot IN-6021-R	Container Foot IN-6021-TF



FLEXIBLE BRONCHOSCOPE TRAY	
Holds: • 1 Flexible Bronchoscope • Accommodates scopes from 12-27" in working length	
19 5/8 L x 9 5/8 W x 3 H (in)	498 L x 244 W x 76 H (mm)
Wrapped Foot IN-6024-R	Container Foot IN-6024-TF



FLEXIBLE SCOPE + LIGHT SOURCE TRAY	
Holds: • 1 Flexible Scope with Attached Light Source • Accommodates scopes from 12-27" in working length	
19 5/8 L x 9 5/8 W x 3 H (in)	498 L x 244 W x 76 H (mm)
Wrapped Foot IN-6022-R	Container Foot IN-6022-TF



FLEXIBLE VIDEO SCOPE TRAY	
Holds: • 1 Flexible Video Scope • Accommodates scopes from 12-27" in working length	
19 5/8 L x 9 5/8 W x 3 H (in)	498 L x 244 W x 76 H (mm)
Wrapped Foot IN-6023-R	Container Foot IN-6023-TF

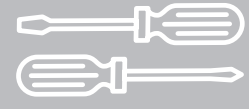

### Custom Configured Tray Example for Flexible Scope

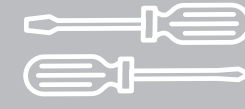

### Custom Configured Tray Example for Flexible Scope

#### FLEXIBLE URETEROSCOPE | 2 INSTRUMENTS

#### VIDEO LARYNGOSCOPE | 1 INSTRUMENT

**BEFORE**



**BEFORE**



**CUSTOM CONFIGURED**

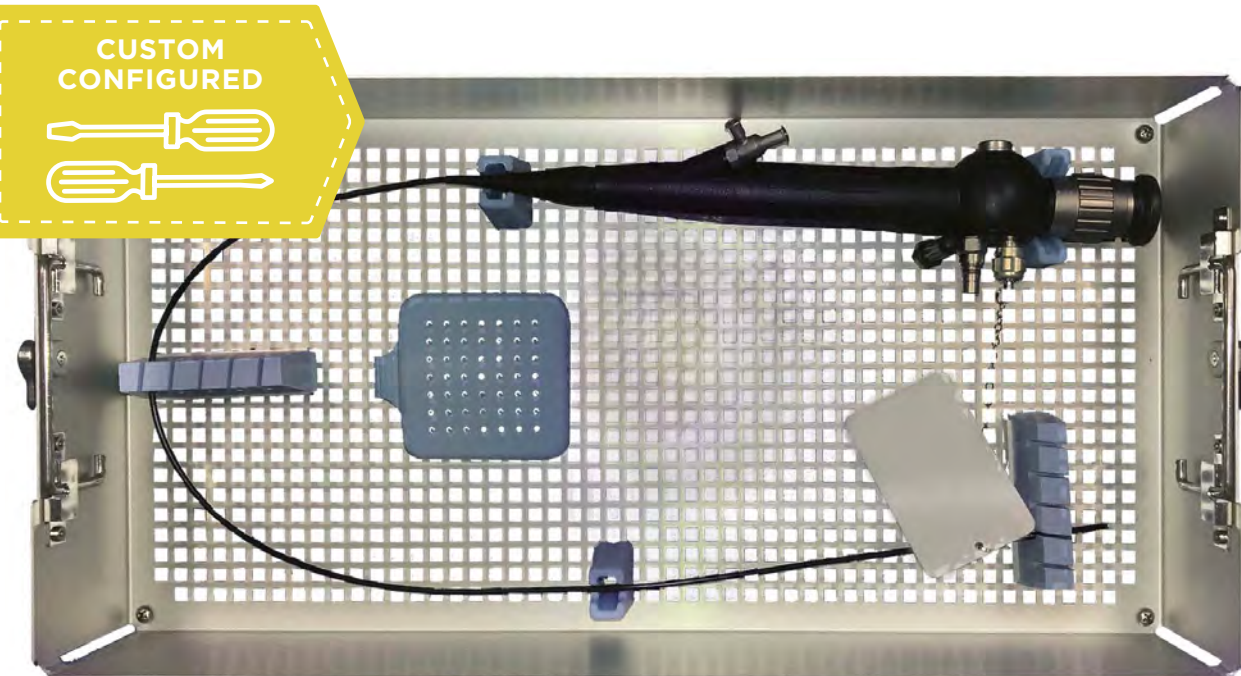
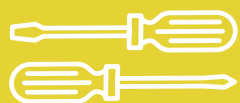

**CUSTOM CONFIGURED**

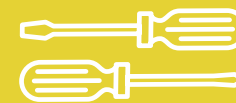

**AFTER**

**AFTER**

Tray shown without cover for illustrative purposes. All custom InstruSafe Trays come with a cover to provide 360 degrees of protection.

Tray shown without cover for illustrative purposes. All custom InstruSafe Trays come with a cover to provide 360 degrees of protection.

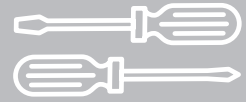

### Custom Configured Tray Example for Flexible Scope

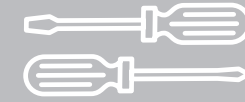

### Custom Configured Tray Example for Flexible Scope

COLONOSCOPY TRAY | 1 INSTRUMENT

FLEXIBLE SCOPE TRAY | 3 INSTRUMENTS

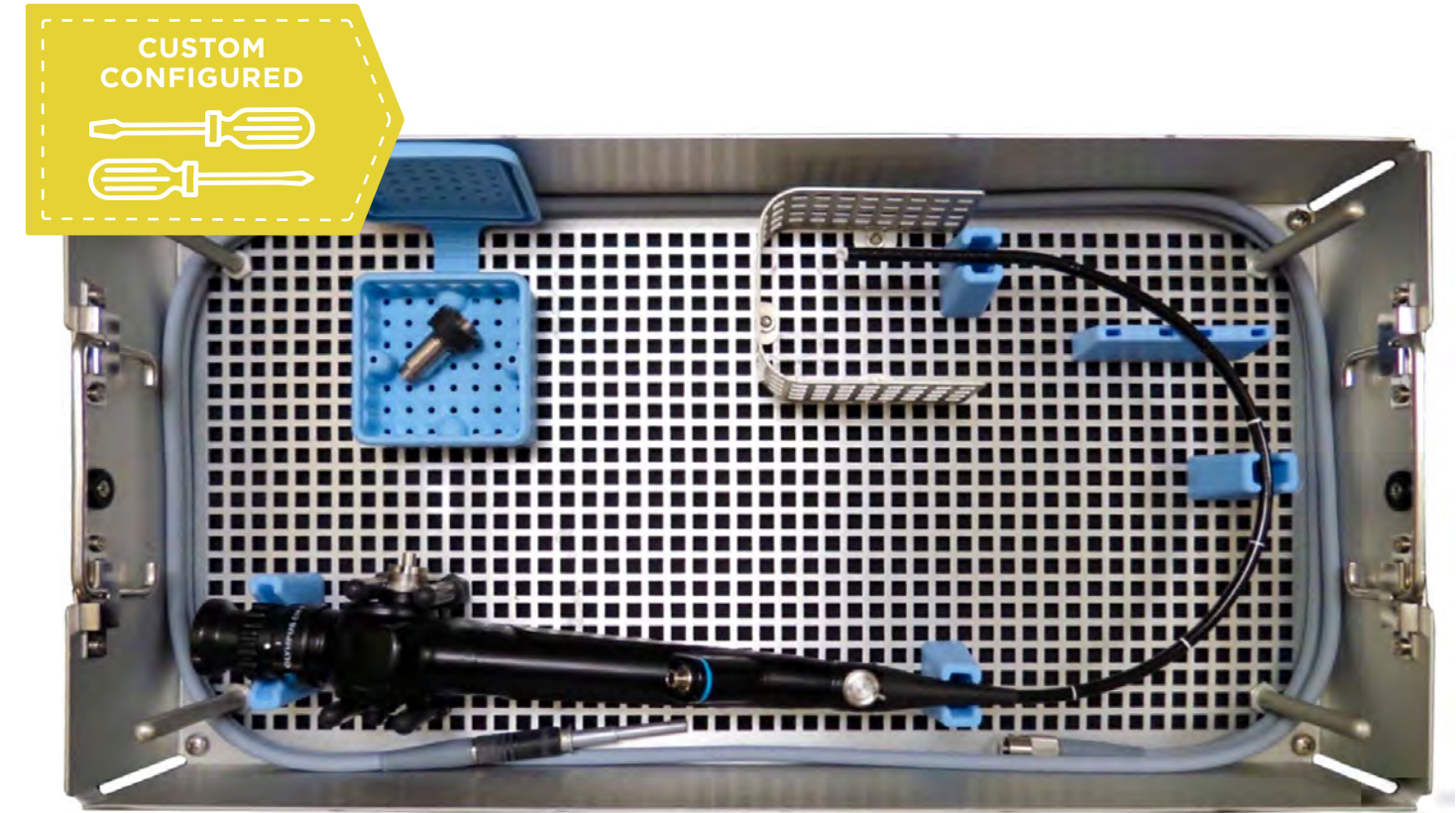
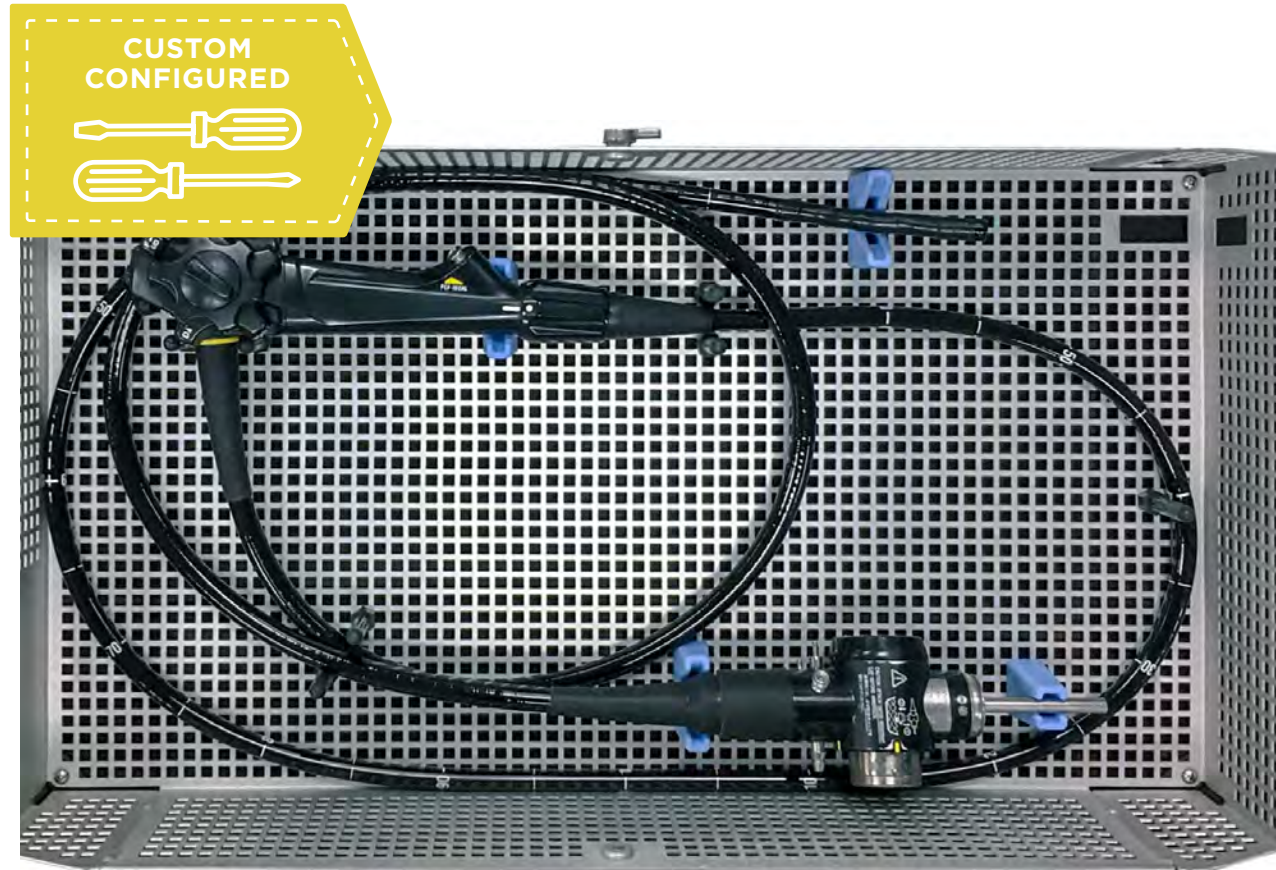

Tray shown without cover for illustrative purposes. All custom InstruSafe Trays come with a cover to provide 360 degrees of protection.

Tray shown without cover for illustrative purposes. All custom InstruSafe Trays come with a cover to provide 360 degrees of protection.



## Preconfigured Trays for da Vinci SP®

The storage and reprocessing of the da Vinci SP isn't limited to a single solution. That's why we've designed multiple trays specific to the system's instrumentation to accommodate a wide variety of customer preferences.



## Preconfigured Trays for da Vinci SP®

ARTHRO  
BARIATRIC  
CARDIO  
DENTAL  
ENT  
GENERAL  
GYN  
NEURO  
EYE  
ORTHO  
PLASTICS  
RETRACTORS  
SCOPES  
ROBOTICS  
ACCESSORIES  
TRANSPORT CONTAINERS

ARTHRO  
BARIATRIC  
CARDIO  
DENTAL  
ENT  
GENERAL  
GYN  
NEURO  
EYE  
ORTHO  
PLASTICS  
RETRACTORS  
SCOPES  
ROBOTICS  
ACCESSORIES  
TRANSPORT CONTAINERS

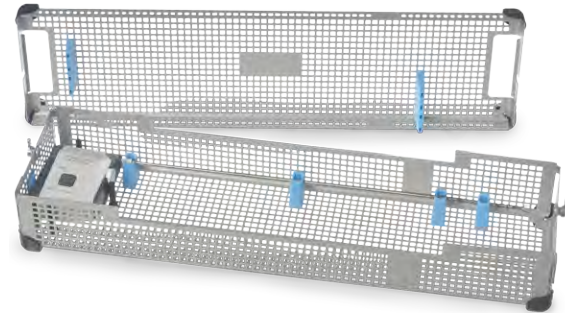

SINGLE INSTRUMENT TRAY	
Holds: • 1 Instrument	
26 3/4 L x 6 7/8 W x 3 3/4 H (in)	679 L x 175 W x 95 H (mm)
Wrapped Foot IN-8921-R	Container Foot IN-8921-TF

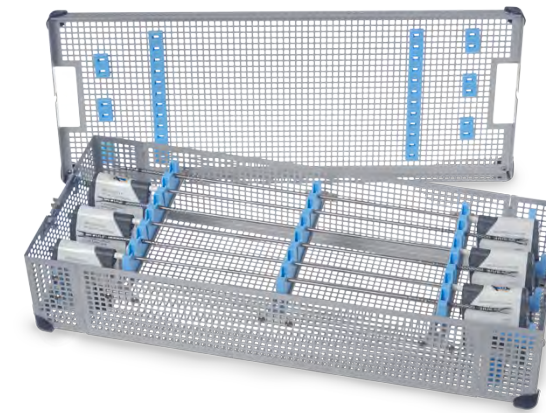

SIX INSTRUMENT TRAY	
Holds: • 6 Instruments	
28 L x 11 W x 5 3/8 H (in)	711 L x 279 W x 137 H (mm)
Wrapped Foot IN-8925-R	Container Foot IN-8925-TF

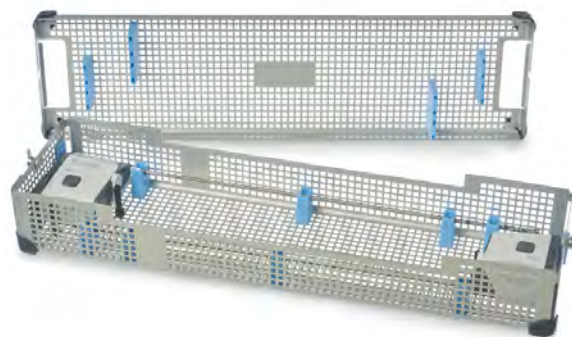

DUAL INSTRUMENT TRAY	
Holds: • 2 Instruments	
26 3/4 L x 6 7/8 W x 3 3/4 H (in)	679 L x 175 W x 95 H (mm)
Wrapped Foot IN-8922-R	Container Foot IN-8922-TF

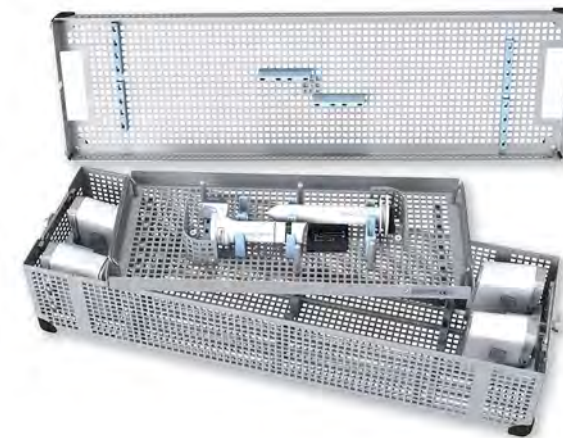

FOUR INSTRUMENT PROCEDURE TRAY	
Holds: • 4 Instruments + Associated Accessories	
28 L x 8 W x 5 3/8 H (in)	711 L x 203 W x 137 H (mm)
Wrapped Foot IN-8924-R	Container Foot IN-8924-TF

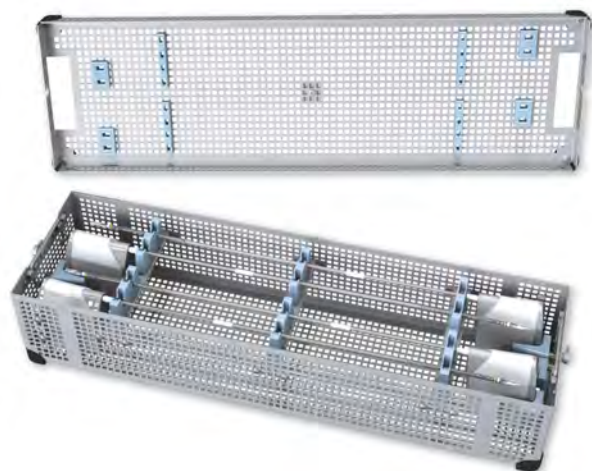

FOUR INSTRUMENT TRAY	
Holds: • 4 Instruments	
28 L x 8 W x 5 3/8 H (in)	711 L x 203 W x 137 H (mm)
Wrapped Foot IN-8923-R	Container Foot IN-8923-TF

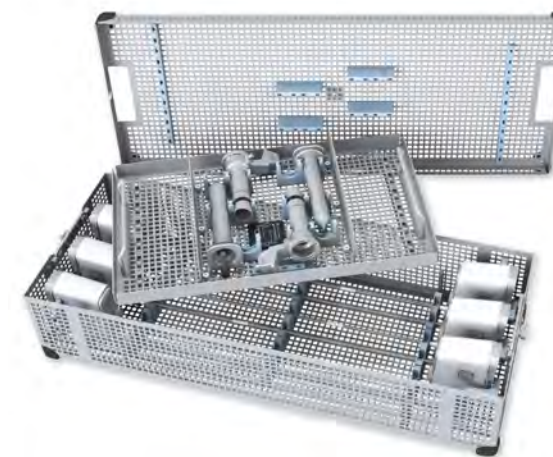

SIX INSTRUMENT PROCEDURE TRAY	
Holds: • 6 Instruments + Associated Accessories	
28 L x 11 W x 5 3/8 H (in)	711 L x 279 W x 137 H (mm)
Wrapped Foot IN-8926-R	Container Foot IN-8926-TF

da Vinci, SP, Xi, EndoWrist and Single-Site are all registered trademarks of Intuitive Surgical, Inc.

da Vinci, SP, Xi, EndoWrist and Single-Site are all registered trademarks of Intuitive Surgical, Inc.



## Preconfigured Trays for da Vinci SP®



## Preconfigured Trays for da Vinci Xi®

As robotic surgery evolves, so do our trays. Constructed for da Vinci Xi Instruments our trays are recommended solutions for instrument reprocessing.

- ARTHRO
- BARIATRIC
- CARDIO
- DENTAL
- ENT
- GENERAL
- GYN
- NEURO
- EYE
- ORTHO
- PLASTICS
- RETRACTORS
- SCOPES
- ROBOTICS
- ACCESSORIES
- TRANSPORT CONTAINERS

- ARTHRO
- BARIATRIC
- CARDIO
- DENTAL
- ENT
- GENERAL
- GYN
- NEURO
- EYE
- ORTHO
- PLASTICS
- RETRACTORS
- SCOPES
- ROBOTICS
- ACCESSORIES
- TRANSPORT CONTAINERS



SIX ACCESSORY TRAY	
Holds:	
<ul style="list-style-type: none"> <li>• 2 Cannulas</li> <li>• 2 Obturators</li> <li>• 2 Cables</li> </ul>	
15 ¼ L x 9 ¾ W x 2 ¾ H (in)	387 L x 244 W x 60 H (mm)
Wrapped Foot IN-8927-R	Container Foot IN-8927-TF



SINGLE CAMERA TRAY	
Holds:	
<ul style="list-style-type: none"> <li>• 1 Camera</li> </ul>	
28 L x 11 W x 3 H (in)	711 L x 279 W x 76 H (mm)
Wrapped Foot IN-8920-R	Container Foot IN-8920-TF



Xi SINGLE INSTRUMENT TRAY	
Holds:	
<ul style="list-style-type: none"> <li>• 1 EndoWrist Instrument</li> </ul>	
27 ⅞ L x 3 ½ W x 2 ½ H (in)	689 L x 89 W x 54 H (mm)
Wrapped Foot IN-8931-R	



Xi DUAL INSTRUMENT TRAY	
Holds:	
<ul style="list-style-type: none"> <li>• 2 EndoWrist instruments</li> </ul>	
27 ⅞ L x 3 ¾ W x 3 ½ H (in)	689 L x 86 W x 89 H (mm)
Wrapped Foot IN-8947-R	



Xi THREE INSTRUMENT TRAY	
Holds:	
<ul style="list-style-type: none"> <li>• 3 EndoWrist instruments</li> </ul>	
26 ¾ L x 6 ⅞ W x 3 ¾ H (in)	679 L x 175 W x 94 H (mm)
Wrapped Foot IN-8948-R	Container Foot IN-8948-TF

da Vinci, SP, Xi, EndoWrist and Single-Site are all registered trademarks of Intuitive Surgical, Inc.

Preconfigured Trays for  
**da Vinci Xi®**



Preconfigured Trays for  
**da Vinci Xi®**

ARTHRO  
BARIATRIC  
CARDIO  
DENTAL  
ENT  
GENERAL  
GYN  
NEURO  
EYE  
ORTHO  
PLASTICS  
RETRACTORS  
SCOPES  
ROBOTICS  
ACCESSORIES  
TRANSPORT CONTAINERS

ARTHRO  
BARIATRIC  
CARDIO  
DENTAL  
ENT  
GENERAL  
GYN  
NEURO  
EYE  
ORTHO  
PLASTICS  
RETRACTORS  
SCOPES  
ROBOTICS  
ACCESSORIES  
TRANSPORT CONTAINERS

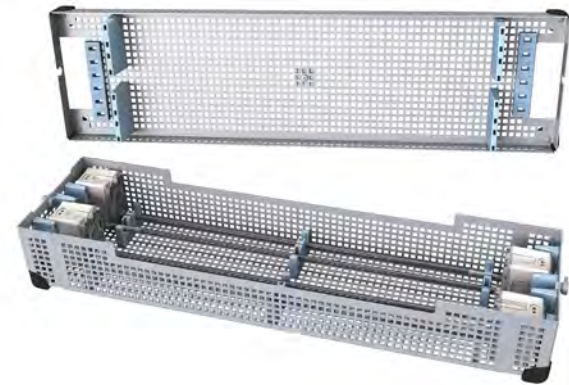

Xi FOUR INSTRUMENT TRAY	
Holds: • 4 EndoWrist Instruments	
26 3/4 L x 6 7/8 W x 3 3/4 H (in)	679 L x 175 W x 94 H (mm)
Wrapped Foot IN-8950-R	Container Foot IN-8950-TF



Xi SIX INSTRUMENT TRAY	
Holds: • 6 EndoWrist Instruments	
26 3/4 L x 10 W x 3 5/8 H (in)	679 L x 254 W x 92 H (mm)
Wrapped Foot IN-8936-R	Container Foot IN-8936-TF

Pairs with our XL Container  
Call your local Rep to learn more!



Xi EIGHT INSTRUMENT TRAY	
Holds: • 8 EndoWrist Instruments	
26 3/4 L x 13 W x 3 5/8 H (in)	679 L x 330 W x 92 H (mm)
Wrapped Foot IN-8938-R	



Xi THREE INSTRUMENT + ACCESSORY TRAY	
Holds: • 3 EndoWrist Instruments + Associated Accessories	
26 3/4 L x 6 7/8 W x 3 3/4 H (in)	679 L x 175 W x 94 H (mm)
Wrapped Foot IN-8949-R	Container Foot IN-8949-TF



Xi FOUR INSTRUMENT PROCEDURE TRAY	
Holds: • 4 EndoWrist Instruments + Associated Accessories	
28 L x 8 W x 5 7/16 H (in)	711 L x 203 W x 138 H (mm)
Wrapped Foot IN-8915-R	Container Foot IN-8915-TF

Pairs with our XL Container  
Call your local Rep to learn more!

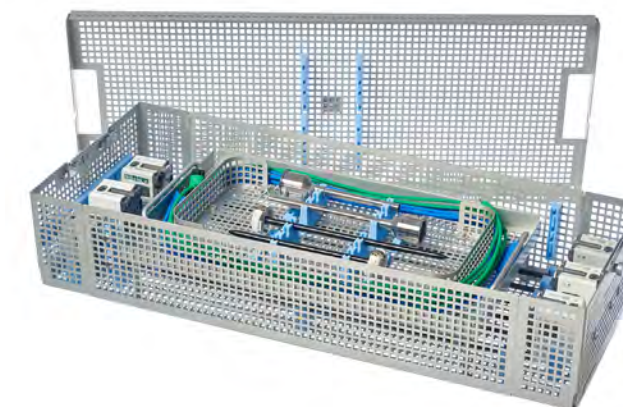

Xi SIX INSTRUMENT PROCEDURE TRAY	
Holds: • 6 EndoWrist Instruments + Associated Accessories	
28 L x 11 W x 5 3/8 H (in)	711 L x 279 W x 137 H (mm)
Wrapped Foot IN-8916-R	Container Foot IN-8916-TF

Pairs with our XL Container  
Call your local Rep to learn more!

da Vinci, SP, Xi, EndoWrist and Single-Site are all registered trademarks of Intuitive Surgical, Inc.

da Vinci, SP, Xi, EndoWrist and Single-Site are all registered trademarks of Intuitive Surgical, Inc.



Preconfigured Trays for  
**da Vinci Xi®**



Preconfigured Trays for  
**da Vinci Xi®**

ARTHRO  
BARIATRIC  
CARDIO  
DENTAL  
ENT  
GENERAL  
GYN  
NEURO  
EYE  
ORTHO  
PLASTICS  
RETRACTORS  
SCOPES  
ROBOTICS  
ACCESSORIES  
TRANSPORT CONTAINERS

ARTHRO  
BARIATRIC  
CARDIO  
DENTAL  
ENT  
GENERAL  
GYN  
NEURO  
EYE  
ORTHO  
PLASTICS  
RETRACTORS  
SCOPES  
ROBOTICS  
ACCESSORIES  
TRANSPORT CONTAINERS



**XI EIGHT INSTRUMENT PROCEDURE TRAY**

Holds:  
• 8 EndoWrist Instruments + Associated Accessories

26 ¾ L x 13 W x 3 ⅝ H (in)	679 L x 330 W x 92 H (mm)
Wrapped Foot IN-8935-R	



**TEN ACCESSORY TRAY**

Holds:  
• 6 Cannulas or Obturators  
• 1 Release Tool  
• 3 Cables

19 ⅝ L x 9 ⅝ W x 2 H (in)	498 L x 244 W x 51 H (mm)
Wrapped Foot IN-8939-R	Container Foot IN-8939-TF



**SINGLE STAPLER + ACCESSORY TRAY**

Holds:  
• 1 Stapler Instrument + Associated Accessories

27 ⅞ L x 3 ⅝ W x 3 ½ H (in)	689 L x 86 W x 89 H (mm)
Wrapped Foot IN-8933-R	



**SINGLE SCOPE TRAY**

Holds:  
• 1 (8mm) 0° or 30° Scope

24 ⅞ L x 13 ½ W x 4 ⅝ H (in)	632 L x 343 W x 111 H (mm)
Wrapped Foot INS-8930-R	

Compatible with Sterrad and V-Pro



**DUAL STAPLER + ACCESSORY TRAY**

Holds:  
• 2 Stapler Instruments + Associated Accessories

26 ¾ L x 6 ⅞ W x 3 ⅞ H (in)	679 L x 175 W x 94 H (mm)
Wrapped Foot IN-8932-R	Container Foot IN-8932-TF

Pairs with our XL Container  
Call your local Rep to learn more!

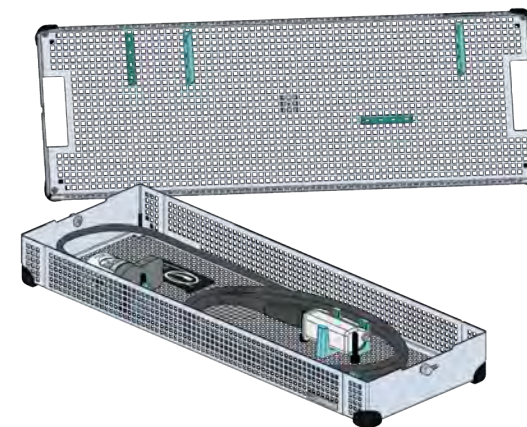

**SINGLE SCOPE TRAY FOR V-PRO**

Holds:  
• 1 (8mm) 0° or 30° Scope

28 ⅞ L x 9 ⅝ W x 2 ¾ H (in)	714 L x 244 W x 70 H (mm)
Wrapped Foot IN-8941-R	

Compatible with V-Pro only



Preconfigured Trays for  
**da Vinci Xi®**



Preconfigured Trays for  
**da Vinci 5®**

ARTHRO  
BARIATRIC  
CARDIO  
DENTAL  
ENT  
GENERAL  
GYN  
NEURO  
EYE  
ORTHO  
PLASTICS  
RETRACTORS  
SCOPES  
ROBOTICS  
ACCESSORIES  
TRANSPORT CONTAINERS

ARTHRO  
BARIATRIC  
CARDIO  
DENTAL  
ENT  
GENERAL  
GYN  
NEURO  
EYE  
ORTHO  
PLASTICS  
RETRACTORS  
SCOPES  
ROBOTICS  
ACCESSORIES  
TRANSPORT CONTAINERS



SINGLE CAMERA TRAY	
Holds: • 1 Handheld Camera	
15 ¼ L x 9 ⅝ W x 3 H (in)	387 L x 244 W x 76 H (mm)
Wrapped Foot INS-8934-R	Container Foot INS-8934-TF

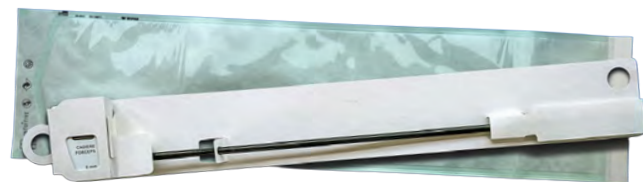

ROBOTIC ARM INSTRUMENT PROTECTOR	
Holds: • 1 Robotic Arm	
26 ⅝ L x X 3 1⅜ W 1 ⅞ H (in)	676 L x X 97 x 48 H (mm)
IN-1033	

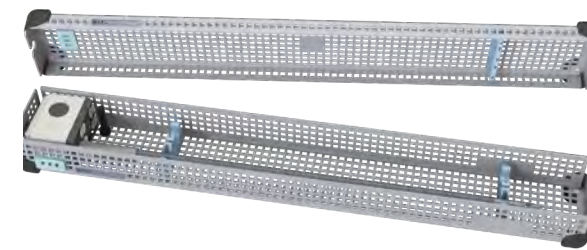

SINGLE INSTRUMENT TRAY	
Holds: • 1 EndoWrist Instrument	
27 ⅞ L x 3 ½ W x 2 ⅞ H (in)	689 L x 89 W x 54 H (mm)
Wrapped Foot IN-8951-R	

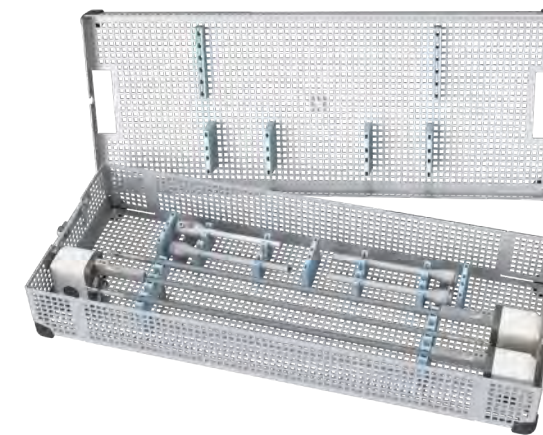

THREE INSTRUMENT + ACCESSORY TRAY	
Holds: • 3 EndoWrist Instrument + Associated Accessories	
28 L x 11 W x 3 ⅝ H (in)	711 L x 279 W x 92 H (mm)
Wrapped Foot IN-8955-R	



SINGLE SCOPE TRAY	
Holds: • 1 (8mm) 0° or 30° Scope	
24 ⅞ L x 13 ½ W x 4 ⅜ H (in)	632 L x 343 W x 111 H (mm)
Wrapped Foot INS-8930-R	

Compatible with Sterrad and V-Pro

**Need to transport your Xi® or DV5® instruments?  
SEE PAGE 84 & 85 FOR DETAILS**

da Vinci, SP, Xi, EndoWrist and Single-Site are all registered trademarks of Intuitive Surgical, Inc.

da Vinci, SP, Xi, EndoWrist and Single-Site are all registered trademarks of Intuitive Surgical, Inc.



Preconfigured Trays for  
**Hugo™ RAS**

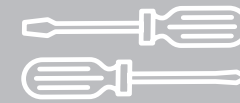

Custom Configured Tray Example for  
**Robotic Instrumentation**

ARTHRO

BARIATRIC

CARDIO

DENTAL

ENT

GENERAL

GYN

NEURO

EYE

ORTHO

PLASTICS

RETRACTORS

SCOPES

ROBOTICS

ACCESSORIES

TRANSPORT CONTAINERS

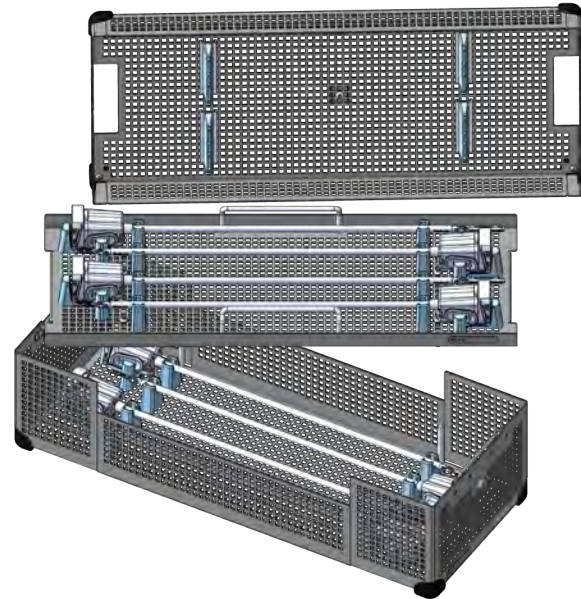

8 WRISTED INSTRUMENT TRAY	
Holds: • 8 Instruments	
24 3/4 L x 9 5/8 W x 6 H (in)	629 L x 244 W x 152 H (mm)
Wrapped Foot IN-8760-R	Tall Foot IN-8760-TF



ENDOSCOPE ACCESSORIES TRAY	
Holds: • 1 Endoscope Adapter • 4 Sims	
19 5/8 L x 9 5/8 W x 4 1/8 H (in)	498 L x 244 W x 105 H (mm)
Wrapped Foot IN-8761-R	Tall Foot IN-8761-TF

**Have other needs for your Hugo robot?  
Contact us today to learn about other options.**

ROBOTIC LAPAROSCOPIC SET | 9 INSTRUMENTS

**BEFORE**



**CUSTOM CONFIGURED**

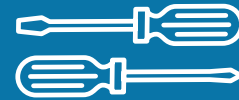

**AFTER**

ARTHRO

BARIATRIC

CARDIO

DENTAL

ENT

GENERAL

GYN

NEURO

EYE

ORTHO

PLASTICS

RETRACTORS

SCOPES

ROBOTICS

ACCESSORIES

TRANSPORT CONTAINERS

Hugo RAS is a trademark of Medtronic.

Tray shown without cover for illustrative purposes. All custom InstruSafe Trays come with a cover to provide 360 degrees of protection.

# Silicone Small Parts Boxes

Don't sweat the small stuff. Made of silicone, these boxes are perfect for keeping extra delicate small parts and accessories organized and protected.



SILICONE SMALL PARTS BOX	
3"x3" Small Parts Box	
3 L x 3 W x 3/4 H (in)	76 L x 76 W x 19 H (mm)
IN-2652	



SILICONE SMALL PARTS BOX	
3"x6" Small Parts Box	
6 L x 3 W x 3/4 H (in)	152 L x 76 W x 19 H (mm)
IN-2653	

- Made of medical grade silicone
- Protection for small parts
- Tethered cover to prevent accidental loss
- Can be attached to trays or placed on posts for easy removal

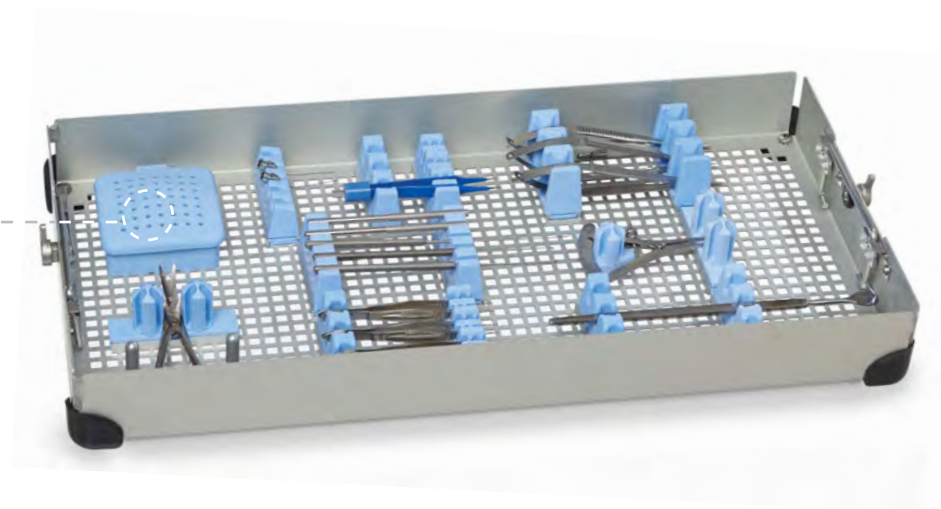

Small Parts Box is shown within tray. Tray is shown without cover for illustrative purposes only.

# Plaque Options

A variety of plaque colors are available to help identify specific sets by procedure or service type. Common identification uses are for bar code placement, tray name labels, or other custom information. Laser engraving of plaques is provided at an additional cost.

Our in-house laser engraving capabilities allow us to personalize trays with custom identification and/or specifications, such as interior instrument descriptions, illustrations, exterior procedure types, specialty, or facility information.

PLAQUE ASSEMBLY FOR TRAYS	
<b>SILVER</b>	IN-2550-01
1 L x 4 3/8 W (in)	25 L x 111 (mm)
<b>BLACK</b>	IN-2550-05
1 L x 4 3/8 W (in)	25 L x 111 (mm)
<b>BLACK</b>	IN-2550-15
1 L x 4 3/8 W (in)	25 L x 111 (mm)
	IN-2600-XX <i>Please indicate desired color of plaque using corresponding number below in place of XX using the color options table.</i>
4 3/8 L x 2 W (in)	111 L x 51 W (mm)
	IN-2300-XX <i>Please indicate desired color of plaque using corresponding number below in place of XX using the color options table.</i>
2 L x 2 1/8 W (in)	51 L x 56 W (mm)

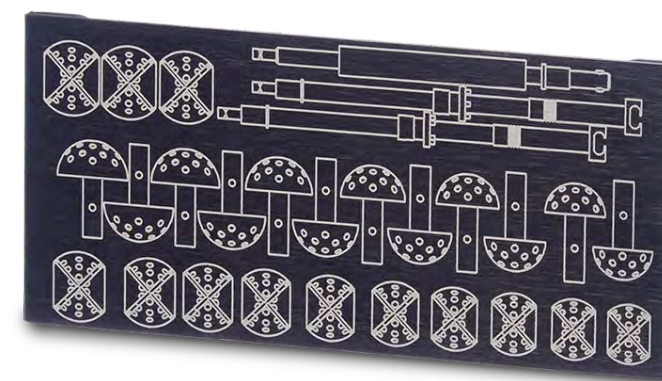

COLOR OPTIONS		Recommended for Steam Sterilization	Recommended for Low-Temp Sterilization	
01	SILVER		N/A	
02	RED		RED	12
03	GREEN		GREEN	13
04	BLUE		BLUE	14
05	BLACK		BLACK	15
07	PURPLE		PURPLE	17
08	ORANGE		N/A	

# Finger Mats

These textured silicone instrument cushion mats are available in a variety of sizes and textures to fit all of your instrument protection needs.

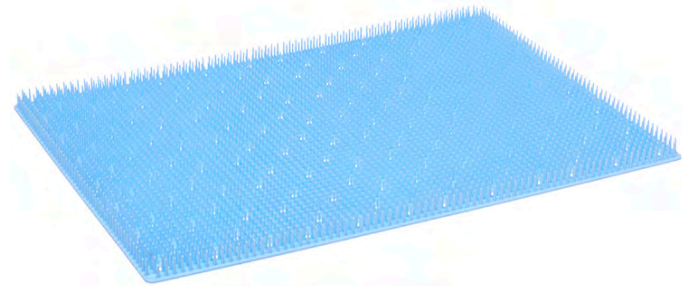

FULL SHEET	
Fine Finger Mat	
19 L x 13 W (in)	483 L x 330 W (mm)
IN-2616	

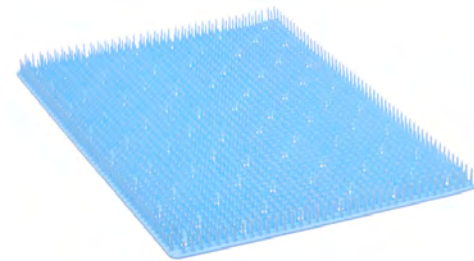

HALF SHEET	
Fine Finger Mat	
9 1/2 L x 13 W (in)	241 L x 330 W (mm)
IN-2617	

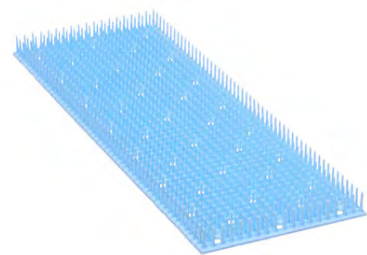

QUART SHEET	
Fine Finger Mat	
4 3/4 L x 13 W (in)	121 L x 330 W (mm)
IN-2618	

# Guardian™ Tray

Simple, small instrument sets now have a new home. Our silicone finger mats with sidewalls provide a safe and pliable environment for them to reside.



GUARDIAN TRAY	
Anodized Aluminum Tray with Finger Mat	
10 L x 6 W x 1 1/4 H (in)	254 L x 152 W x 32 H (mm)
IN-1310	

- Accommodate a wide variety of small instrumentation
- Feature built-in and vented silicone finger mats
- Reduce instrument repair and replacement costs

# Instru-Zyme®

This powerful enzyme and detergent formulation is designed to assist in the removal of blood, tissue, mucus and other proteinaceous materials.



INSTRU-ZYME GEL	
Properties:	
• Specific Gravity: 1.200	• Color: Light Blue
• pH: 7.8	• Form: Liquid Gel
• Tropical Fragrance	
<i>Currently for U.S. Sales Only</i>	
Quantity 6 Bottles/Case	
IN-1032	

# Rounders® Point Guards®

Wrap your trays with confidence. Point Guards are engineered to sit securely on almost any tray corner. Help prevent holes and tears in your sterilization wrap caused by surgical trays that are heavy, have sharp corners or are improperly handled.



ROUNDERS POINT GUARDS	
Reusable and economical	
Quantity 80/Bag	
IN-7330	

- Air cushion tray corner protection
- Can be used in steam, ethylene oxide and low temperature plasma sterilization
- Patent #9119611
- Non-sterile

**MADE IN THE USA**

# XL Transport Containers

Transporting da Vinci scopes, and EndoWrist instruments appropriately and effectively is a difficult task. Use the InstruSafe XL Transport Container to get the job done right! This durable container is the perfect size, enabling you to protect your instruments while they travel from the O.R. to sterile processing.

## XL Transport Container Special Features

- Highly durable material designed to withstand everyday use
- Cart wash safe—maximum temperature of 230°F
- Made in the USA



XL TRANSPORT CONTAINER	
Holds: • 1 da Vinci Xi or SP Endoscope OR up to 8 da Vinci Xi or SP EndoWrist Instruments and accessories	
34 L x 17 ¼ W x 6 H (in)	864 L x 438 W x 152 H (mm)
With Drain IN-PIC-20-D	Without Drain IN-PIC-20



XL TRANSPORT CONTAINER WITH LIFTING TRAY	
Holds: • Lifting Tray • 1 da Vinci Xi or SP Endoscope OR up to 8 da Vinci Xi or SP EndoWrist Instruments and accessories	
34 L x 17 ¼ W x 6 H (in)	864 L x 438 W x 152 H (mm)
*LIFTING TRAY DIMENSIONS BELOW	
With Drain IN-PIC-20-D-LT	Without Drain IN-PIC-20-LT



SINGLE ENDOSCOPE LIFTING TRAY	
Holds: • 1 da Vinci Xi or SP Endoscope and accessories	
27 ½ L x 13 ½ W x 3 ¾ H (in)	699 L x 343 W x 98 H (mm)
IN-PIC-34	

MULTIPLE INSTRUMENT LIFTING TRAY	
Holds: • Up to 8 da Vinci Xi or SP EndoWrist Instruments and accessories	
27 ½ L x 13 ½ W x 3 ¾ H (in)	699 L x 343 W x 98 H (mm)
IN-PIC-34	



\*Top view of lid



### CONFIGURATION EXAMPLES

#### LIFTING TRAY

**Single Endoscope Configuration**  
Holds: 1 da Vinci Xi or SP Endoscope



**Multiple Instrument Configuration**  
Holds: up to 8 da Vinci Xi or SP EndoWrist Instruments

# Heavy Duty Transport Containers

These containers are designed with a silicone gasket and locking cover to reduce spills and leakage while transporting contaminated instruments. They are similar to our other transport containers but have a more robust construction and feature stainless steel hinges and latches that can be easily undone with just one hand.

# Transport Containers

These containers are designed with a silicone gasket and locking cover to reduce spills and leakage while transporting contaminated instruments. Also, you can easily identify content through the transparent amber color.



SHORT CONTAINER	
Heavy Duty Transport Container	
20 1/2 L x 12 5/8 W x 3 3/4 H (in)	521 L x 321 W x 95 H (mm)
IN-PIC-15	



TALL CONTAINER	
Heavy Duty Transport Container	
20 L x 12 1/4 W x 6 1/8 H (in)	510 L x 310 W x 156 H (mm)
IN-PIC-16	



SMALL, SHORT CONTAINER	
Transport Container	
13 1/16 L x 15 5/8 W x 4 5/16 H (in)	345 L x 398 W x 110 H (mm)
IN-PIC-14	



LARGE, SHORT CONTAINER	
Transport Container	
20 5/8 L x 15 5/8 W x 5 5/16 H (in)	524 L x 397 W x 135 H (mm)
IN-PIC-12	



SMALL, TALL CONTAINER	
Transport Container	
13 9/16 L x 15 5/8 W x 7 1/2 H (in)	345 L x 398 W x 190 H (mm)
IN-PIC-13	



LARGE, TALL CONTAINER	
Transport Container	
20 5/8 L x 15 5/8 W x 7 1/2 H (in)	524 L x 397 W x 191 H (mm)
IN-PIC-11	

# Rigid Container Feature + Benefits

We provide sterile processing and the operating room a system that protects investments inside and out. Our unique instrument protection trays and durable external containers are designed to dramatically reduce instrument repairs and replacement costs. This combination delivers uncompromised surgical instrument sets to aid in a higher quality of clinical care and helps maximize economic value through improved instrument set longevity.

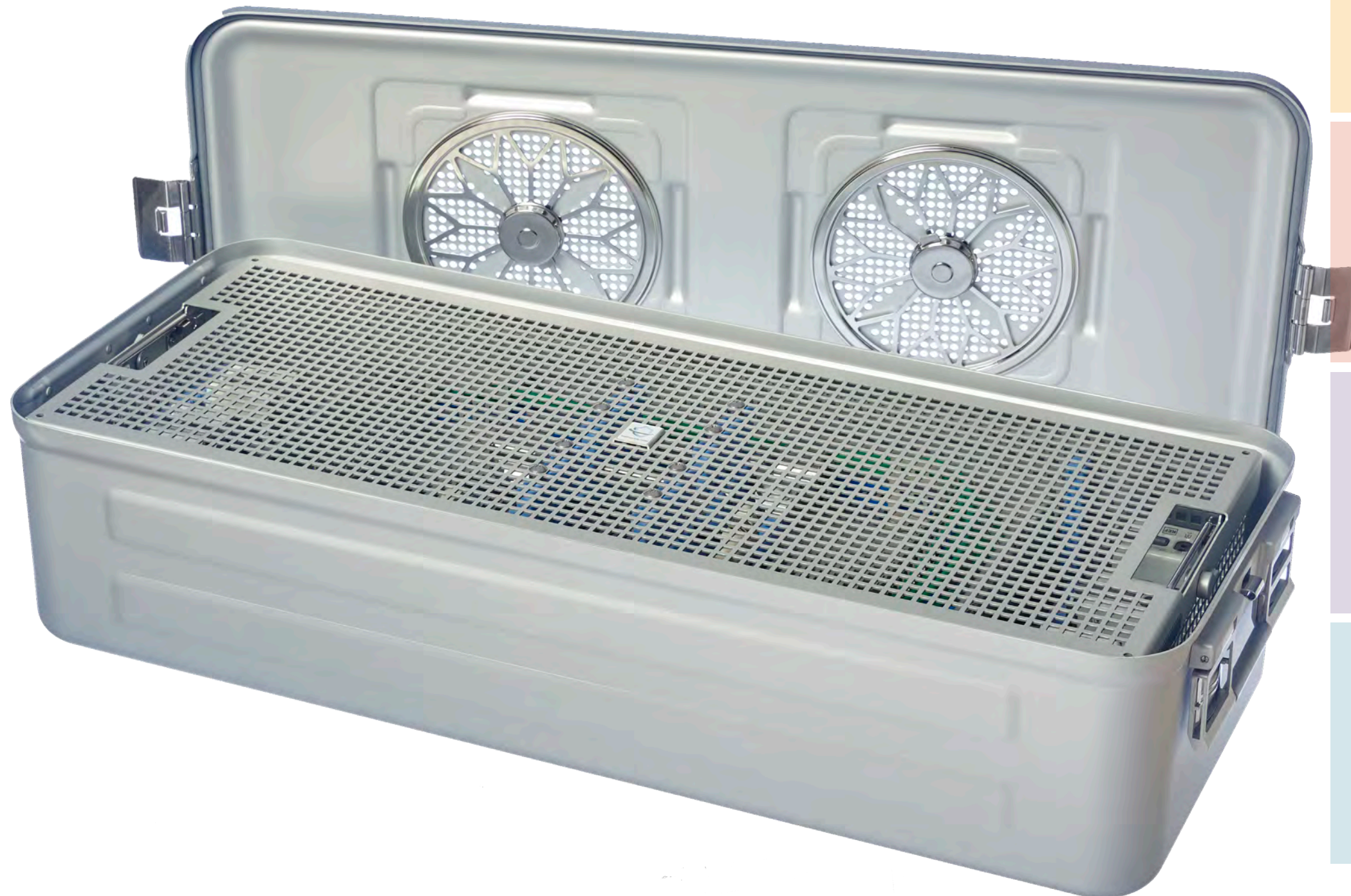

## ANODIZED ALUMINUM

Durable and lightweight material



## FILTER RETENTION PLATES

Easy to install with audible snap when locked in position



## STAINLESS STEEL LATCHES

One step stainless steel locking mechanism eliminates malfunctions



## ERGONOMIC HANDLES

90° stop handles feature ergonomic silicone and flip to read plaques and data cards



## STANDARD + UNIQUE SIZES

Half, three quarters, full and unique XL sizes available



# Lid + Solid Bottoms

# Perforated Bottoms + Basket

HALF  
THREE QUARTER  
FULL  
XL  
ACCESSORIES  
RESOURCES

HALF SIZE  
THREE QUARTER  
FULL  
XL  
ACCESSORIES  
RESOURCES



HALF SIZE LID	
Outside 11 3/4 L x 11 W x 1 1/4 H (in)	
CS-1001	



HALF SIZE 4" PERFORATED BOTTOM	
Outside with Lid 11 3/4 L x 11 W x 4 1/8 H (in)	Usable Inside 10 1/4 L x 10 1/4 W x 2 3/4 H (in)
CS-1012	



HALF SIZE 4" SOLID BOTTOM	
Outside with Lid 11 3/4 L x 11 W x 4 1/8 H (in)	Usable Inside 10 1/4 L x 10 1/4 W x 3 1/4 H (in)
CS-1002	



HALF SIZE 6" PERFORATED BOTTOM	
Outside with Lid 11 3/4 L x 11 W x 5 5/8 H (in)	Usable Inside 10 1/4 L x 10 1/4 W x 4 H (in)
CS-1013	



HALF SIZE 6" SOLID BOTTOM	
Outside with Lid 11 3/4 L x 11 W x 5 5/8 H (in)	Usable Inside 10 1/4 L x 10 1/4 W x 4 1/2 H (in)
CS-1003	



HALF SIZE CONTAINER BASKET	
Outside with Lid 8 1/2 L x 9 3/4 W x 2 3/4 H (in)	Usable Inside 8 3/8 L x 9 5/8 W x 2 H (in)
CS-1120	

# Lid + Solid Bottoms

# Perforated Bottoms + Basket

HALF  
THREE QUARTER  
FULL  
XL  
ACCESSORIES  
RESOURCES

HALF SIZE  
THREE QUARTER  
FULL  
XL  
ACCESSORIES  
RESOURCES



THREE QUARTER SIZE LID	
Outside 18 ¼ L x 11 W x 1 ¼ H (in)	
CS-2001	



THREE QUARTER SIZE 4" PERFORATED BOTTOM	
Outside with Lid 18 ¼ L x 11 W x 4 ½ H (in)	Usable Inside 16 ¾ L x 10 ¼ W x 2 ¾ H (in)
CS-2012	



THREE QUARTER SIZE 4" SOLID BOTTOM	
Outside with Lid 18 ¼ L x 11 W x 4 ½ H (in)	Usable Inside 16 ¾ L x 10 ¼ W x 3 ¼ H (in)
CS-2002	



THREE QUARTER SIZE 6" PERFORATED BOTTOM	
Outside with Lid 18 ¼ L x 11 W x 5 ½ H (in)	Usable Inside 16 ¾ L x 10 ¼ W x 4 H (in)
CS-2013	



THREE QUARTER SIZE 6" SOLID BOTTOM	
Outside with Lid 18 ¼ L x 11 W x 5 ½ H (in)	Usable Inside 16 ¾ L x 10 ¼ W x 4 ½ H (in)
CS-2003	



THREE QUARTER SIZE BASKET	
Outside with Lid 15 ¾ L x 9 ¾ W x 2 ¾ H (in)	Usable Inside 15 ¼ L x 9 ¾ W x 2 H (in)
CS-2120	

# Lid + Solid Bottoms

# Perforated Bottoms + Baskets

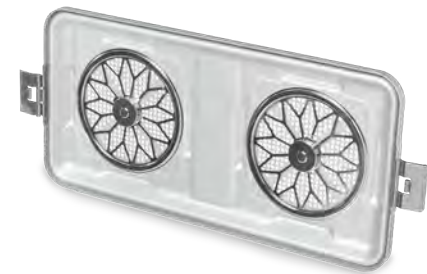

FULL SIZE LID	
Outside 23 1/8 L x 11 W x 1 1/4 H (in)	
CS-3001	



FULL SIZE 4" SOLID BOTTOM	
Outside with Lid 23 1/8 L x 11 W x 4 1/8 H (in)	Usable Inside 21 5/8 L x 10 1/4 W x 3 3/4 H (in)
CS-3002	



FULL SIZE 6" SOLID BOTTOM	
Outside with Lid 23 1/8 L x 11 W x 5 5/8 H (in)	Usable Inside 21 5/8 L x 10 1/4 W x 4 1/2 H (in)
CS-3003	



FULL SIZE 8" SOLID BOTTOM	
Outside with Lid 23 1/8 L x 11 W x 8 1/4 H (in)	Usable Inside 21 5/8 L x 10 1/4 W x 7 1/8 H (in)
CS-3004	



FULL SIZE 10" SOLID BOTTOM	
Outside with Lid 23 1/8 L x 11 W x 10 3/8 H (in)	Usable Inside 21 5/8 L x 10 1/4 W x 9 1/2 H (in)
CS-3005	



FULL SIZE 4" PERFORATED BOTTOM	
Outside with Lid 23 1/8 L x 11 W x 4 1/8 H (in)	Usable Inside 21 5/8 L x 10 1/4 W x 2 3/4 H (in)
CS-3012	



FULL SIZE 6" PERFORATED BOTTOM	
Outside with Lid 23 1/8 L x 11 W x 5 5/8 H (in)	Usable Inside 21 5/8 L x 10 1/4 W x 4 H (in)
CS-3013	



FULL SIZE 8" PERFORATED BOTTOM	
Outside with Lid 23 1/8 L x 11 W x 8 1/4 H (in)	Usable Inside 21 5/8 L x 10 1/4 W x 6 5/8 H (in)
CS-3014	



FULL SIZE 10" PERFORATED BOTTOM	
Outside with Lid 23 1/8 L x 11 W x 10 3/8 H (in)	Usable Inside 21 5/8 L x 10 1/4 W x 9 H (in)
CS-3015	



FULL SIZE CONTAINER BASKETS	
Outside with Lid 19 3/4 L x 9 3/4 W x 2 3/4 H (in)	Usable Inside 19 5/8 L x 9 5/8 W x 2 H (in)
CS-3120	
Outside with Lid 19 3/4 L x 9 3/4 W x 6 3/4 H (in)	Usable Inside 19 5/8 L x 9 5/8 W x 6 H (in)
CS-3160	

# Lid, Bottom + Basket

# Special Features

HALF

THREE QUARTER

FULL

XL

ACCESSORIES

RESOURCES



XL SIZE LID	
Outside 30 3/8 L x 12 3/8 W x 1 1/4 H (in)	
CS-5001	



XL SIZE 8" PERFORATED BOTTOM	
Outside with Lid 30 3/8 L x 12 3/8 W x 7 1/2 H (in)	Usable Inside 28 1/2 L x 11 W x 5 1/2 H (in)
CS-5002	



XL SIZE CONTAINER BASKET	
Outside with Lid 28 1/8 L x 11 1/8 W x 6 1/4 H (in)	Usable Inside 28 L x 11 W x 5 3/8 H (in)
CS-5150	

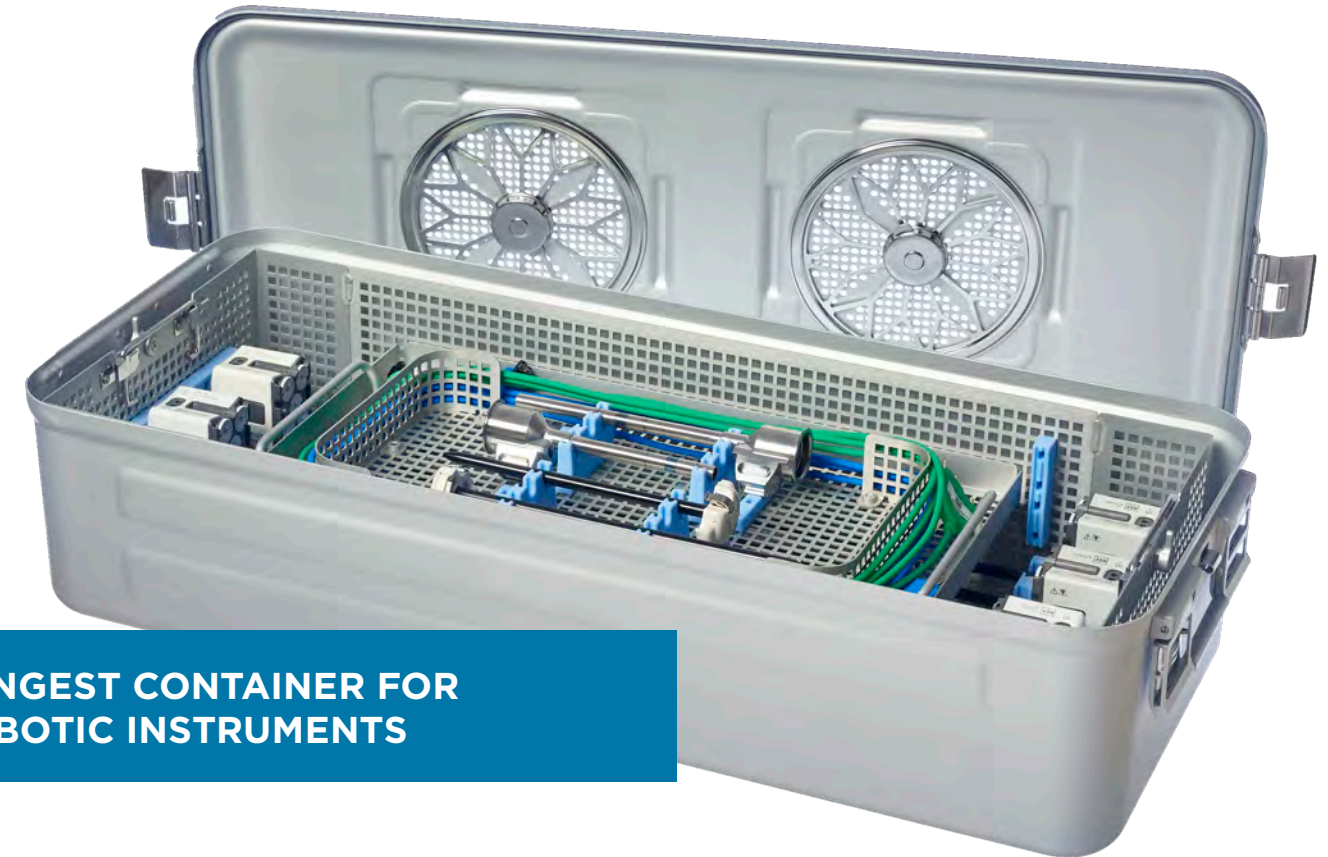

**LONGEST CONTAINER FOR ROBOTIC INSTRUMENTS**

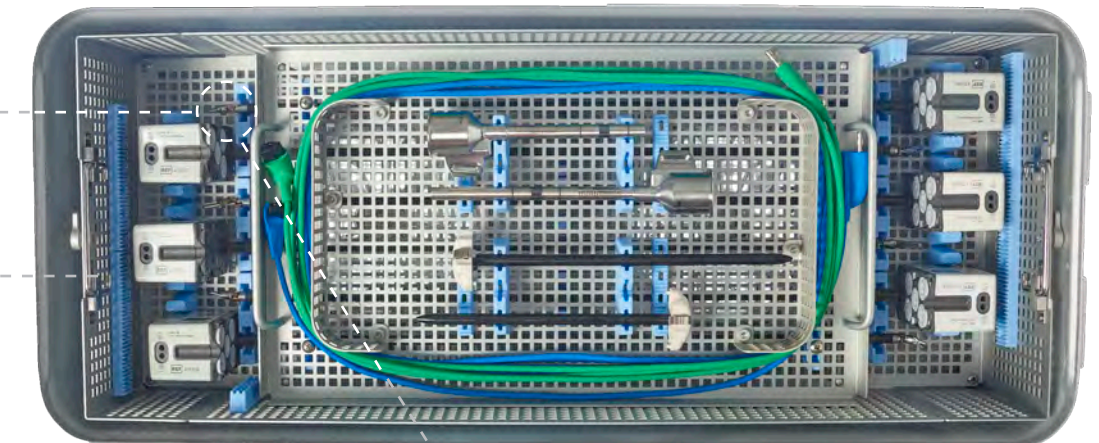

Fits robotic instruments without bending instrument tips

Container designed to hold multiple tray configurations: IN-8915-TF or IN-8916-TF

## ADDITIONAL FEATURES

- Combined weight does not exceed AMMI standard of 25 lbs
- Only available with perforated bottom



POINT CAMERA TO LEARN MORE

# Locks, Filters + Data Cards

# Plaque Options



CONTAINER LOCKS WITH PROCESS INDICATOR	
Quantity	1000
REF	CS-0100



*Our in-house laser engraving capabilities allow us to personalize plaques with custom identification and/or specifications, such as interior instruments, exterior procedure types, specialty or facility information. Engrave up to 13 characters on a single line of text!*



CONTAINER FILTERS	
Quantity	500
REF	ER800.000

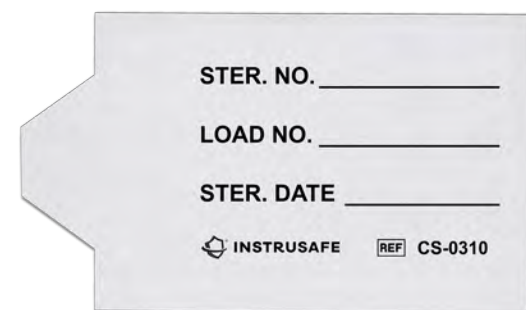

DATA CARDS	
Quantity	250
REF	CS-0310

BLANK CONTAINER PLAQUES		
<i>Color Options</i>		
Indicate plaque color using the corresponding numbers below in place of XX.		
02	RED	
03	GREEN	
04	BLUE	
05	BLACK	
06	YELLOW	
07	VIOLET	
08	ORANGE	
09	BROWN	
Blank CS-5500-XX		Engraved CS-5500-XX-EN



# Metric Measurement Table

# Tray Cross Reference

Container Size	Container Part Number	Outside with Lid (mm)	Usable Inside (mm)
HALF	CS-1001	299 L x 278 W x 32 H	N/A
	CS-1002	299 L x 278 W x 105 H	260 L x 260 W x 83 H
	CS-1003	299 L x 278 W x 143 H	260 L x 260 W x 114 H
	CS-1012	299 L x 278 W x 105 H	260 L x 260 W x 67 H
	CS-1013	299 L x 278 W x 143 H	260 L x 260 W x 102 H
	CS-1120	216 L x 248 W x 51 H	213 L x 244 W x 51 H
THREE QUARTER	CS-2001	464 L x 278 W x 32 H	N/A
	CS-2002	464 L x 278 W x 105 H	425 L x 260 W x 83 H
	CS-2003	464 L x 278 W x 143 H	425 L x 260 W x 114 H
	CS-2012	464 L x 278 W x 105 H	425 L x 260 W x 70 H
	CS-2013	464 L x 278 W x 143 H	425 L x 260 W x 102 H
	CS-2120	391 L x 248 W x 51 H	387 L x 244 W x 51 H
FULL	CS-3001	587 L x 278 W x 32 H	N/A
	CS-3002	587 L x 278 W x 105 H	549 L x 260 W x 83 H
	CS-3003	587 L x 278 W x 143 H	549 L x 260 W x 114 H
	CS-3004	587 L x 278 W x 208 H	549 L x 260 W x 181 H
	CS-3005	587 L x 278 W x 263 H	549 L x 260 W x 241 H
	CS-3012	587 L x 278 W x 105 H	549 L x 260 W x 70 H
	CS-3013	587 L x 278 W x 143 H	549 L x 260 W x 102 H
	CS-3014	587 L x 278 W x 208 H	549 L x 260 W x 168 H
	CS-3015	587 L x 278 W x 263 H	549 L x 260 W x 229 H
	CS-3120	502 L x 248 W x 52 H	498 L x 244 W x 51 H
	CS-3160	502 L x 248 W x 152 H	498 L x 244 W x 152 H
	XL	CS-5001	771 L x 315 W x 32 H
CS-5002		771 L x 315 W x 195 H	724 L x 279 W x 140 H
CS-5150		714 L x 283 W x 140 H	711 L x 279 W x 137 H

Tray Part Number	Container Part Number	
	SOLID	PERFORATED
IN-1306-TF	CS-1002	CS-1012
IN-1310-TF	CS-2002	CS-2012
IN-1315-TF	CS-2002	CS-2012
IN-2006-TF	CS-1003	CS-1013
IN-2840-TF	CS-3004	CS-3014
IN-2841-TF	CS-3004	CS-3014
IN-2842-TF	CS-3004	CS-3014
IN-2847-TF	CS-3005	CS-3015
IN-2890-TF	CS-3004	CS-3014
IN-2950-TF	CS-1003	CS-1013
IN-5010-TF	CS-1003	CS-1013
IN-5011-TF	CS-2002	CS-2012
IN-6021-TF	CS-3003	CS-3013
IN-6022-TF	CS-3003	CS-3013
IN-6023-TF	CS-3003	CS-3013
IN-6024-TF	CS-3003	CS-3013
IN-6031-TF	CS-2003	CS-2013
IN-6500-TF	CS-3003	CS-3013
IN-7008-TF	CS-1002	CS-1012
IN-7010-TF	CS-1002	CS-1012
IN-7011-TF	CS-2003	CS-2013
IN-7014-TF	CS-2003	CS-2013
IN-7020-TF	CS-1002	CS-1012
IN-7030-TF	CS-1003	CS-1013
IN-7120-TF	CS-2002	CS-2012
IN-7123-TF	CS-2003	CS-2013
IN-7130-TF	CS-2003	CS-2013
IN-7140-TF	CS-2003	N/A
IN-7213-TF	CS-3002	CS-3012
IN-7220-TF	CS-3002	CS-3012
IN-7223-TF	CS-3003	CS-3013
IN-7230-TF	CS-3003	CS-3013
IN-7234-TF	N/A	CS-5002
IN-7240-TF	CS-3003	CS-3014
IN-7250-TF	CS-3004	CS-3014
IN-7260-TF	CS-3004	CS-3014
IN-7323-TF	N/A	CS-5002
IN-7344-TF	N/A	CS-5002
IN-7423-TF	N/A	CS-5002
IN-7430-TF	N/A	CS-5002
IN-7533-TF	N/A	CS-5002
IN-7582-TF	N/A	CS-5002

Tray Part Number	Container Part Number	
	SOLID	PERFORATED
IN-7583-TF	N/A	CS-5002
IN-7633-TF	N/A	CS-5002
IN-7644-TF	N/A	CS-5002
IN-8610-TF	CS-2002	CS-2012
IN-8613-TF	CS-2003	CS-2013
IN-8615-TF	CS-1002	CS-1012
IN-8616-TF	CS-1003	CS-1013
IN-8620-TF	CS-3003	CS-3013
IN-8621-TF	CS-3003	CS-3013
IN-8622-TF	CS-2003	CS-2013
IN-8623-TF	CS-2003	CS-2013
IN-8630-TF	CS-3003	CS-3013
IN-8632-TF	CS-3003	CS-3013
IN-8640-TF	CS-3003	CS-3013
IN-8642-TF	CS-3003	CS-3013
IN-8645-TF	CS-3003	CS-3013
IN-8721-TF	CS-2003	CS-2013
IN-8722-TF	CS-1002	CS-1012
IN-8750-TF	CS-3003	CS-3014
IN-8751-TF	CS-3003	CS-3013
IN-8761-TF	CS-3003	CS-3014
IN-8884-TF	CS-2002	CS-2012
IN-8889-TF	N/A	CS-5002
IN-8894-TF	N/A	CS-5002
IN-8897-TF	CS-1003	CS-1013
IN-8898-01-TF	N/A	CS-5002
IN-8899-TF	CS-2003	CS-2013
IN-8913-TF	CS-3003	CS-3014
IN-8914-TF	N/A	CS-5002
IN-8915-TF	N/A	CS-5002
IN-8916-TF	N/A	CS-5002
IN-8932-TF	N/A	CS-5002
IN-8936-TF	N/A	CS-5002
IN-8942-TF	N/A	CS-5002
IN-8943-TF	CS-1003	CS-1013
IN-8944-TF	N/A	CS-5002
IN-8983-TF	N/A	CS-5002
IN-8984-01-TF	N/A	CS-5002
IN-8986-TF	N/A	CS-5002
IN-8987-TF	N/A	CS-5002
IN-8988-TF	N/A	CS-5002
IN-8989-TF	N/A	CS-5002

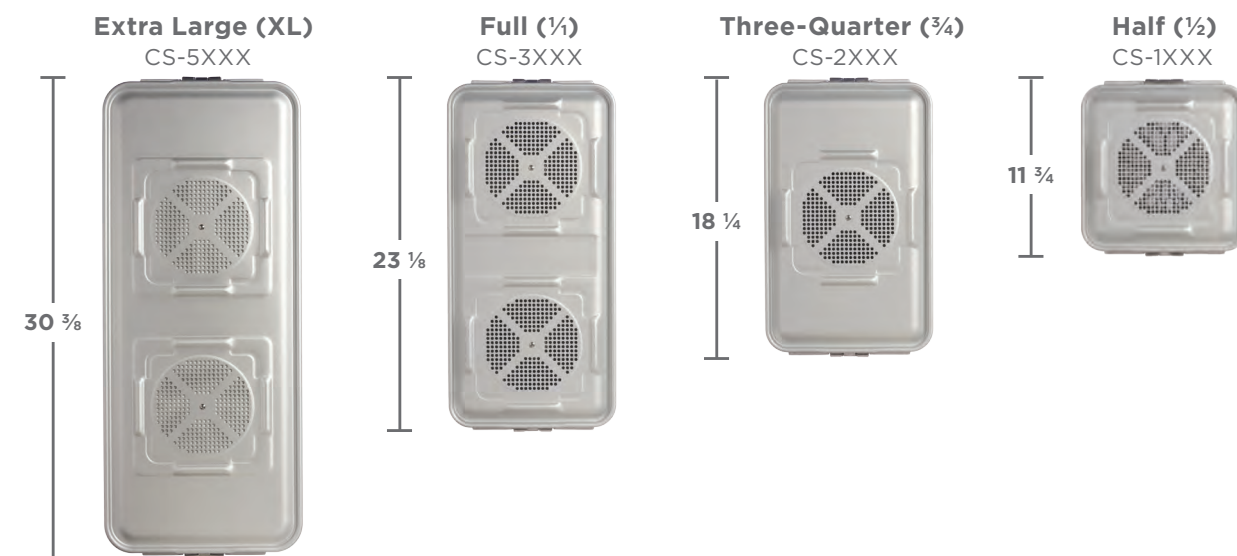



**InstruSafe®**,  
An Innovia Medical Brand

**FOR US + INTERNATIONAL ORDERS:**

**Summit Medical LLC**  
**An Innovia Medical Company**

815 Vikings Parkway  
Suite 100  
St. Paul, MN 55121  
USA

1-888-229-2875  
[www.instrusafe.com](http://www.instrusafe.com)

**FOR UK ORDERS:**

**DTR Medical Ltd**  
**An Innovia Medical Company**

17 Clarion Court,  
Clarion Court Enterprise Park,  
Swansea SA6 8RF  
UK

+44 (0) 1792 797910  
[www.dtrmedical.com](http://www.dtrmedical.com)

InstruSafe® Instrument Protection Trays are proudly made in St. Paul, Minnesota, USA.

InstruSafe® Sterilization Container Systems are proudly made in St. Paul, Minnesota, USA.

Summit Medical LLC is an FDA registered facility, ISO 13485:2016 certified and CMDCAS certified.

InstruSafe® Trays are validated for multiple sterilization cycles to give our customers more options.

Sterilization Containers are validated for multiple sterilization cycles to give our customers more options.

CAUTION: Federal (USA) law restricts these devices for sale by or on the order of a physician. Indications, contraindications, warnings and instructions for use can be found in the product labeling supplied with each device.

Specifications and designs are subject to change without any notice or obligation on the part of the manufacturer.

InstruSafe, Instru-Zyme, Hold-Its™, Hold-Downs™, Rounders Point Guards, and Guardian are trademarks and registered trademarks of Summit Medical.

da Vinci, SP, S, Xi, Single-Site and EndoWrist are registered trademarks of Intuitive Surgical, Inc.

Hugo RAS is a trademark of Medtronic.

The Bookwalter trademark is a registered trademark of Symmetry Surgical, Inc., or its affiliates in the United States and other countries around the world. Original Bookwalter retractors are sold exclusively by Symmetry Surgical, Inc. The Mediflex Bookler Retractor is registered trademark of Mediflex.

All brands are trademarks or registered trademarks of their respective owners.

InstruSafe® is a registered trademarks of Summit Medical LLC.

©2026 Innovia Medical. All rights reserved. MM-IS-5006 | Rev E | APR2026